

CT MOLDINGS

CAPITAL

CTM | CM | 8000

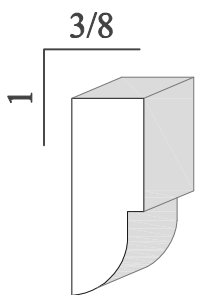

CTM | CM | 8001

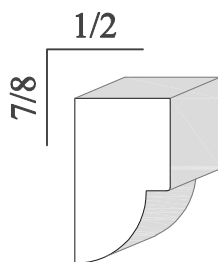

CTM | CM | 8002

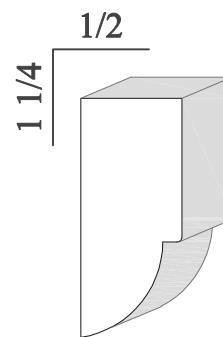

CTM | CM | 8003

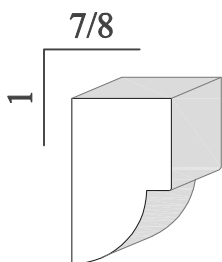

CTM | CM | 8004

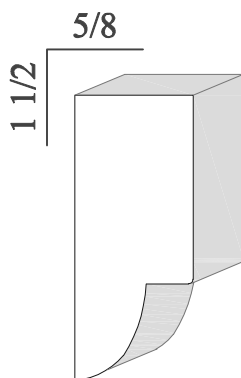

CTM | CM | 8005

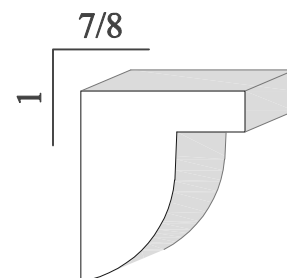

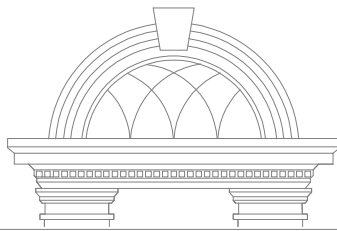

CT MOLDINGS  
CAPITAL

CTM | CM | 8006

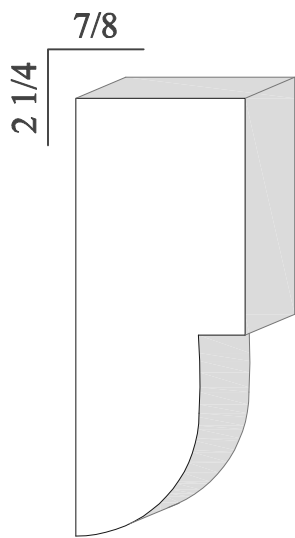

CTM | CM | 8007

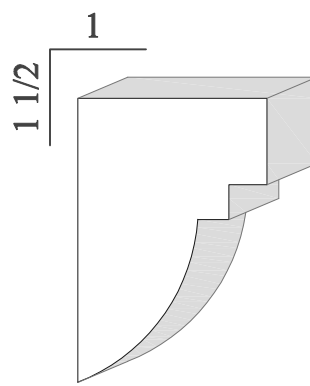

CTM | CM | 8008

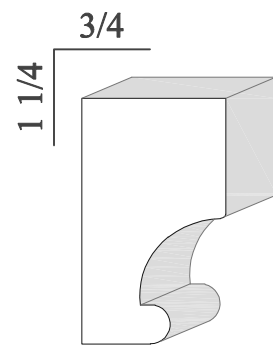

CTM | CM | 8009

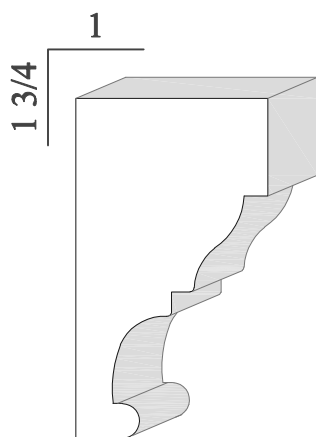

CTM | CM | 8010

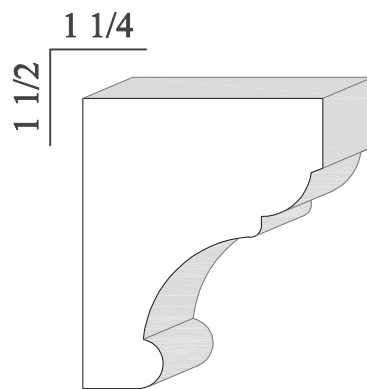

CTM | CM | 8011

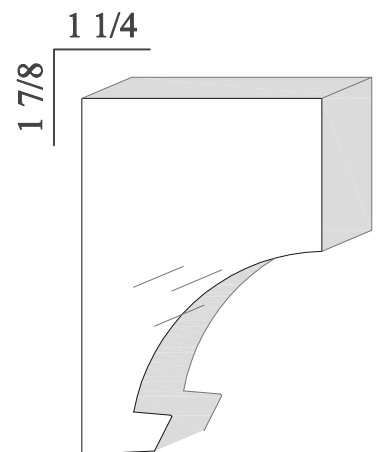

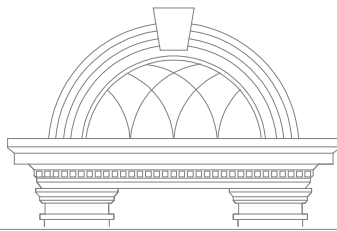

**CT MOLDINGS**  
**CAPITAL**

CTM | CM | 8012

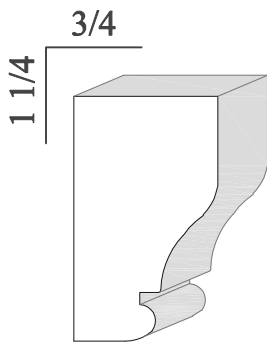

CTM | CM | 8013

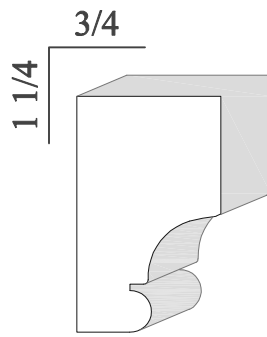

CTM | CM | 8014

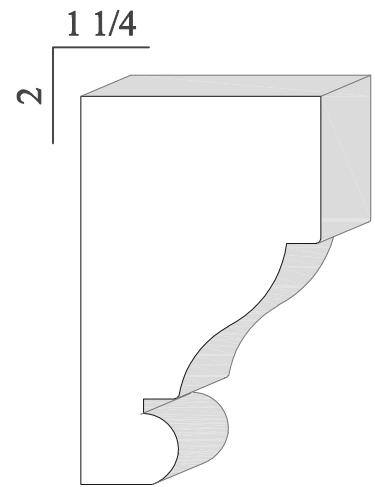

CTM | CM | 8015

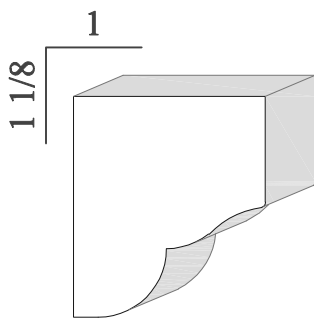

CTM | CM | 8016

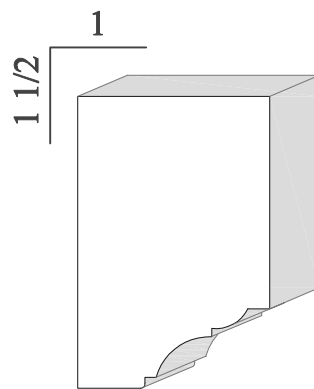

CTM | CM | 8017

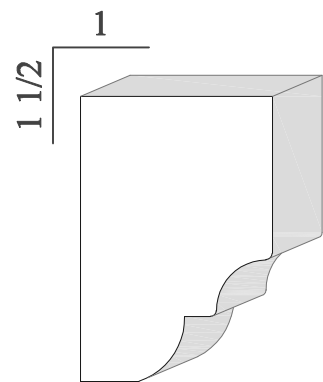

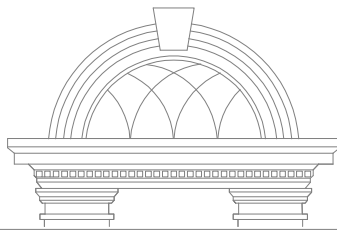

CT MOLDINGS  
CAPITAL

CTM | CM | 8018

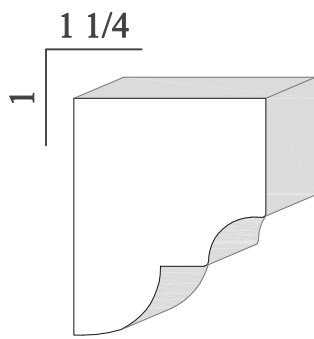

CTM | CM | 8019

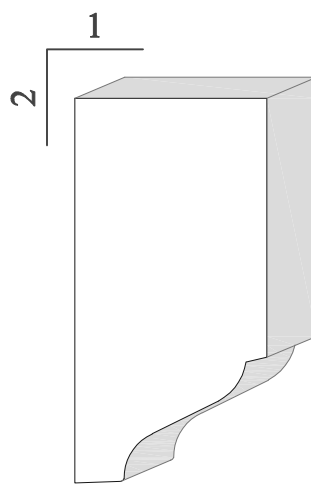

CTM | CM | 8020

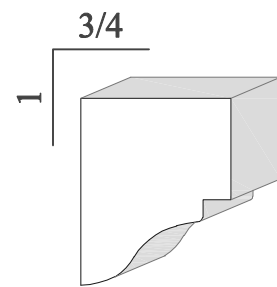

CTM | CM | 8021

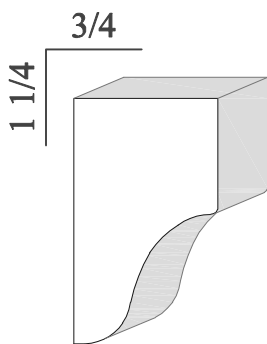

CTM | CM | 8022

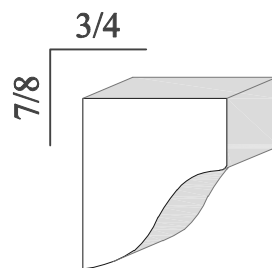

CTM | CM | 8023

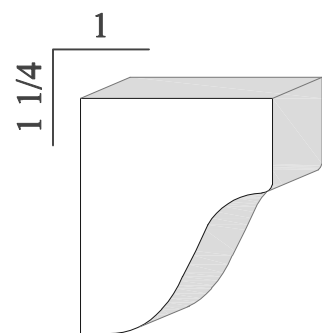

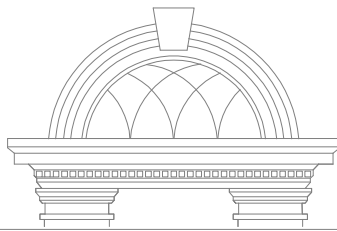

CT MOLDINGS  
CAPITAL

CTM | CM | 8024

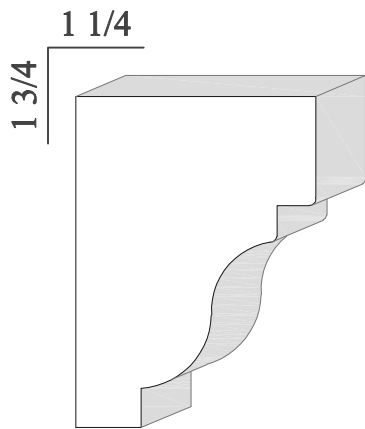

CTM | CM | 8025

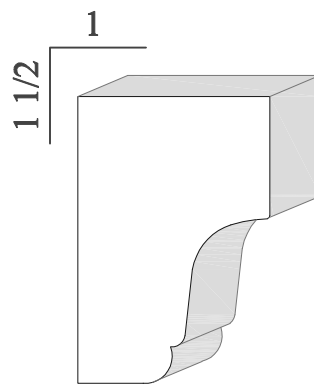

CTM | CM | 8026

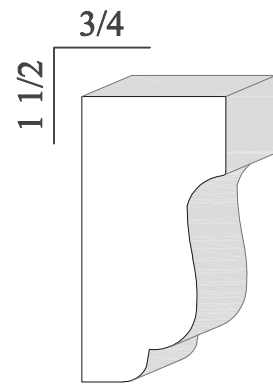

CTM | CM | 8027

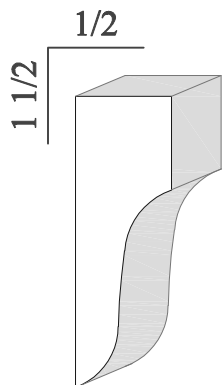

CTM | CM | 8028

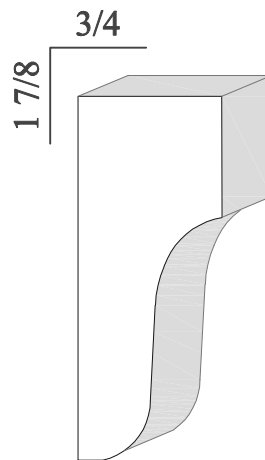

CTM | CM | 8029

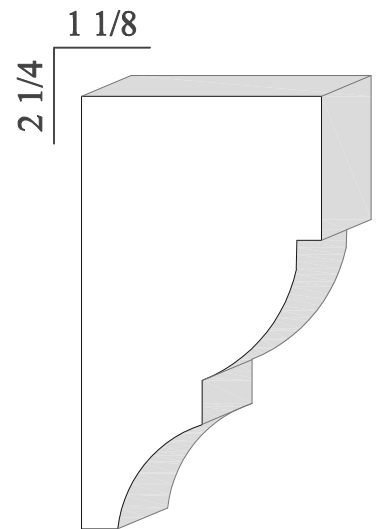



CT MOLDINGS  
CAPITAL

CTM | CM | 8030

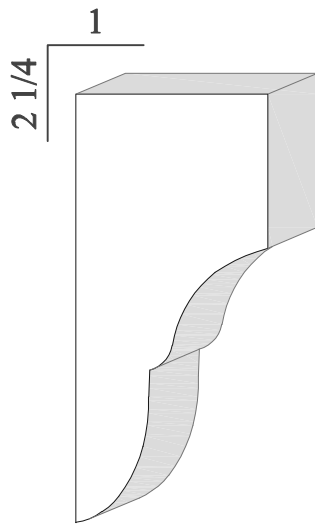

CTM | CM | 8031

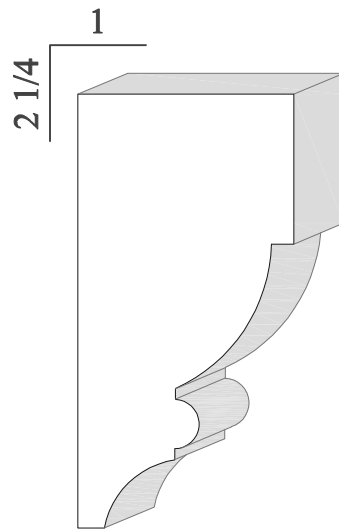

CTM | CM | 8032

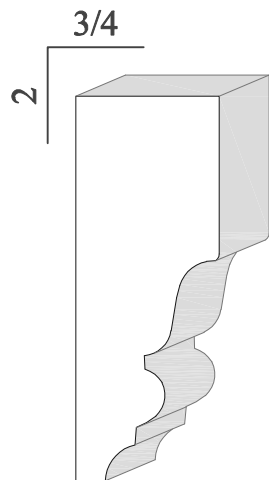

CTM | CM | 8033

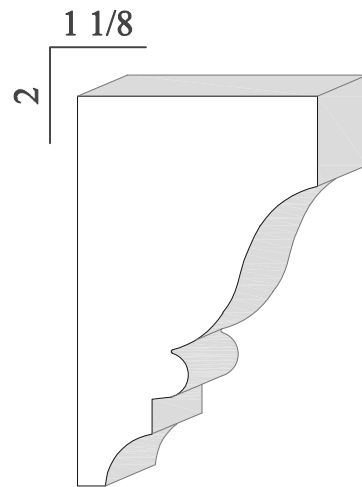

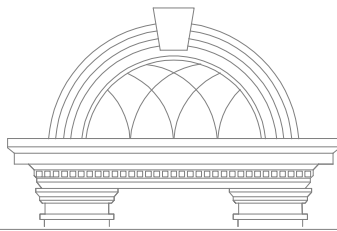

CT MOLDINGS  
CAPITAL

CTM | CM | 8034

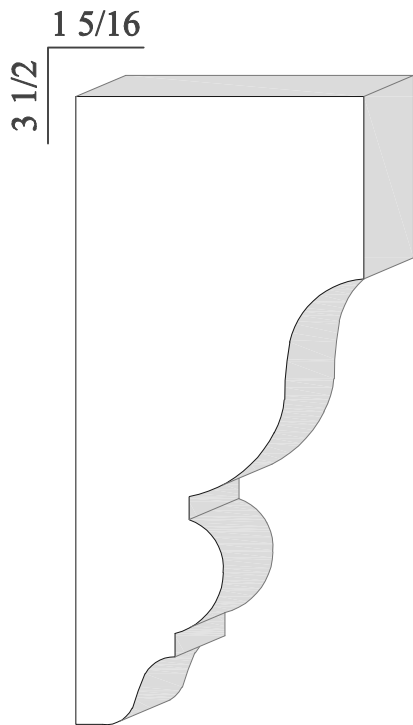

CTM | CM | 8035

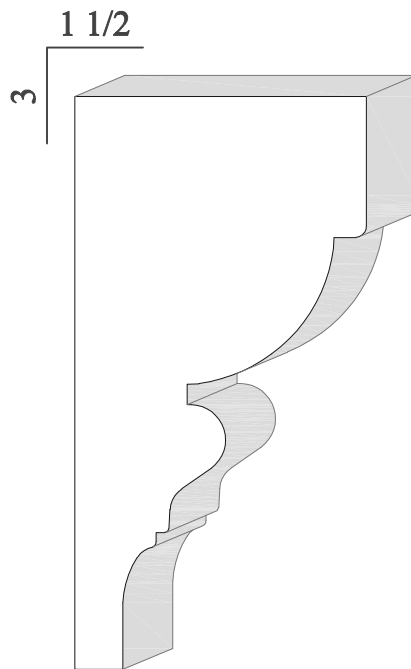

CTM | CM | 8036

