

CT MOLDINGS

BASE CAP

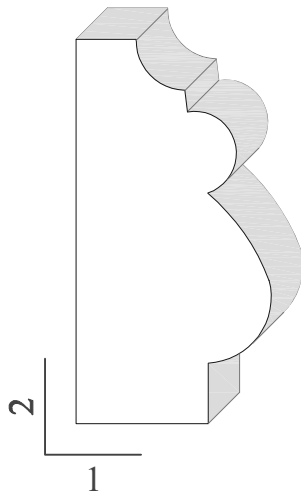

CTM | BC | 6014

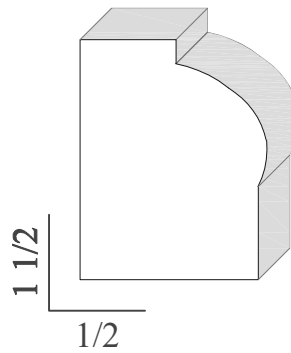

CTM | BC | 6015

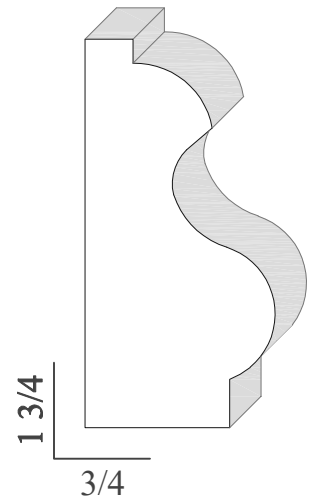

CTM | BC | 6017

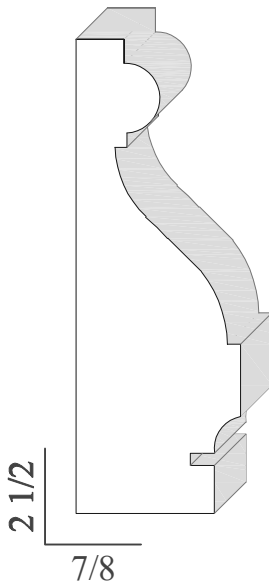

CTM | BC | 6020

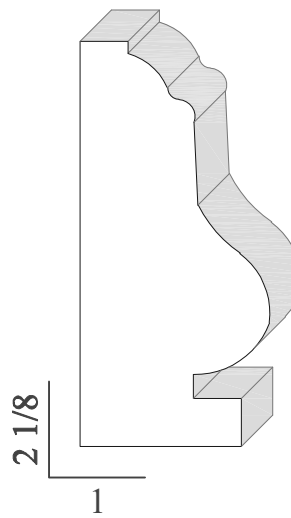

CTM | BC | 6024

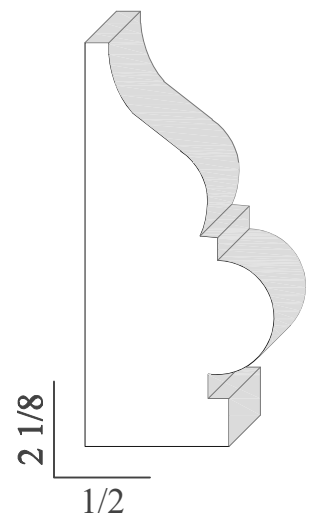

CTM | BC | 6025

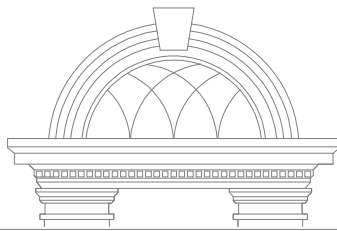

CT MOLDINGS

BASE CAP

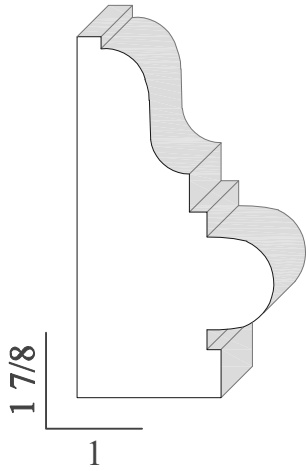

CTM | BC | 6026

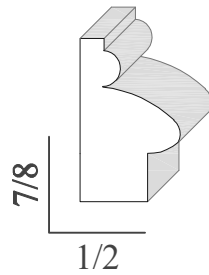

CTM | BC | 6028

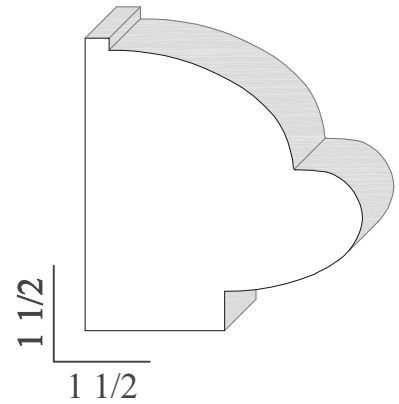

CTM | BC | 6029

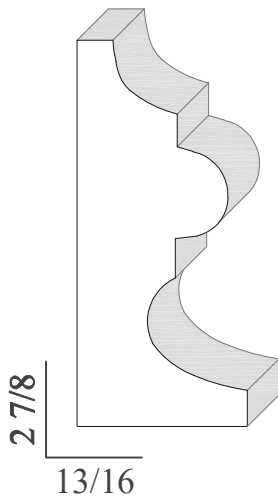

CTM | BC | 6030

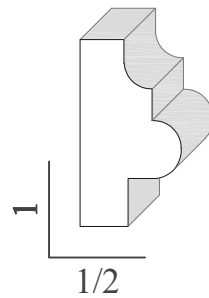

CTM | BC | 6033

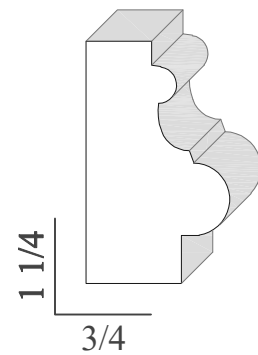

CTM | BC | 6034

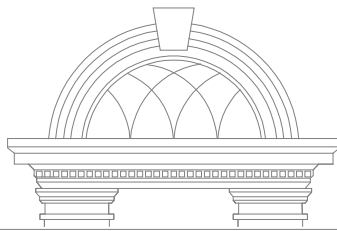

---

CT MOLDINGS

---

BASE CAP

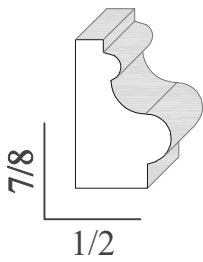

CTM | BC | 6035

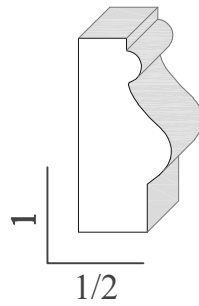

CTM | BC | 6036

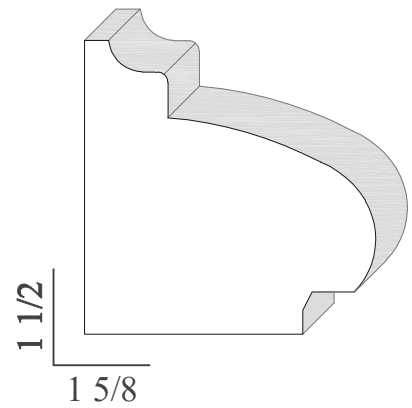

CTM | BC | 6039