

CT MOLDINGS

CASING

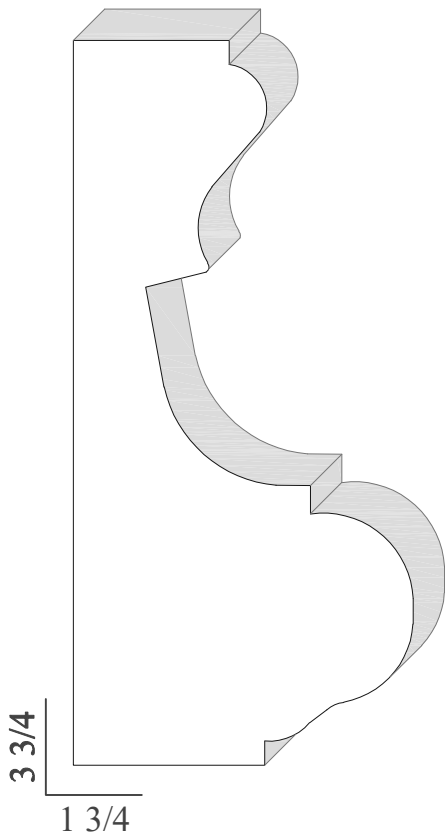

CTM | CA | 4000

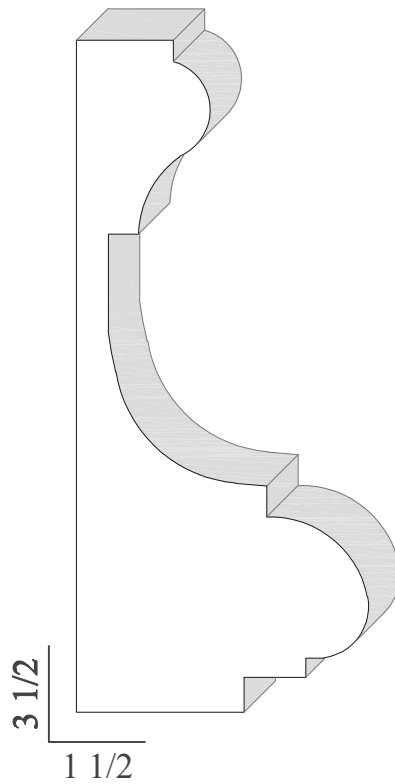

CTM | CA | 4001

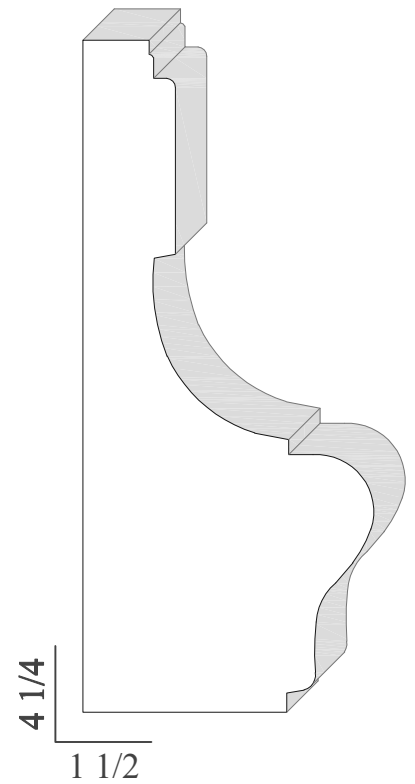

CTM | CA | 4002

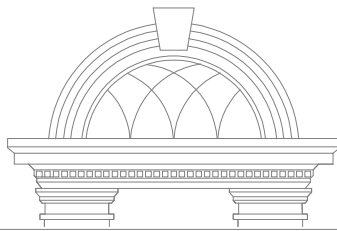

CT MOLDINGS

CASING

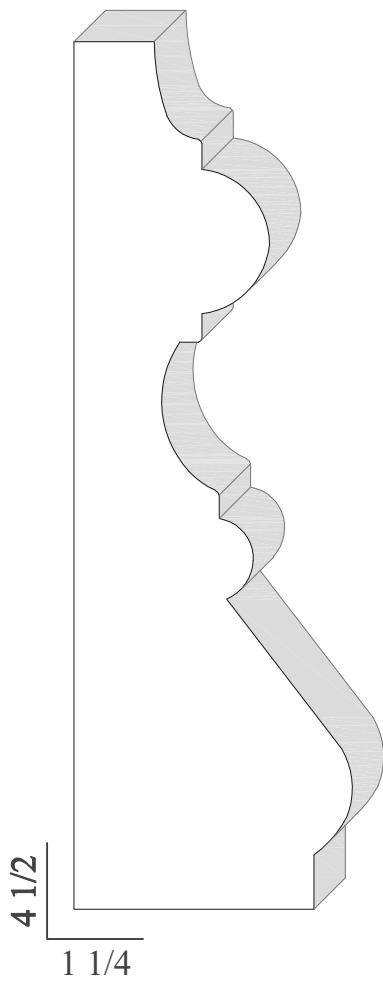

CTM | CA | 4003

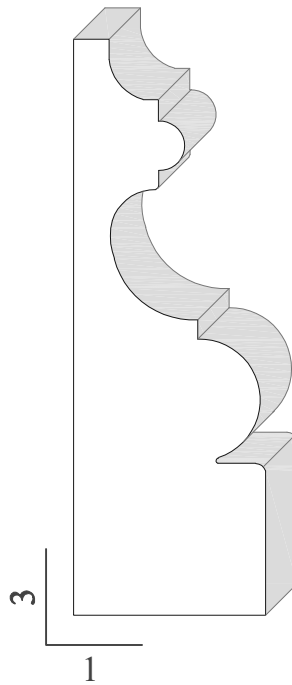

CTM | CA | 4004

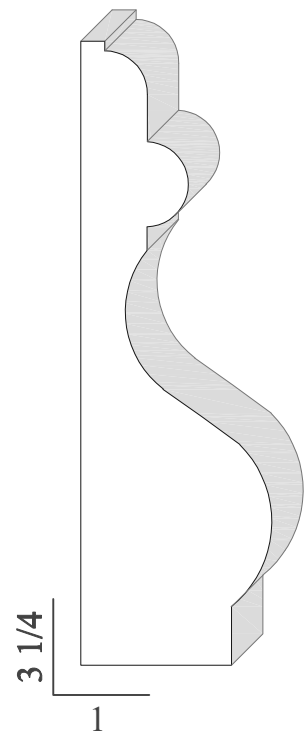

CTM | CA | 4005

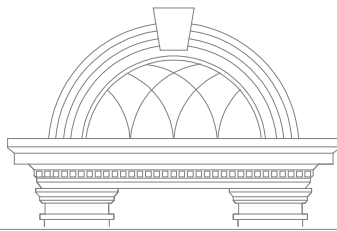

CT MOLDINGS

CASING

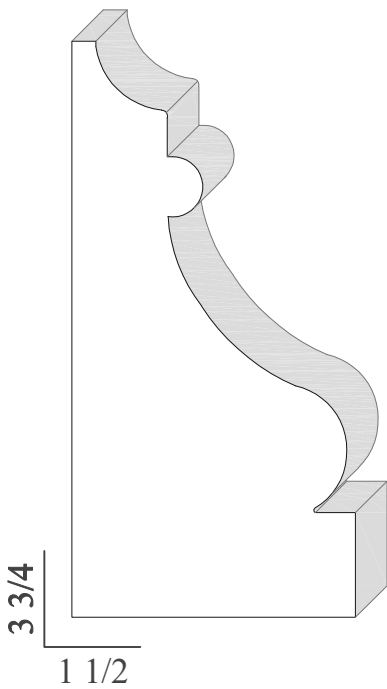

CTM | CA | 4006

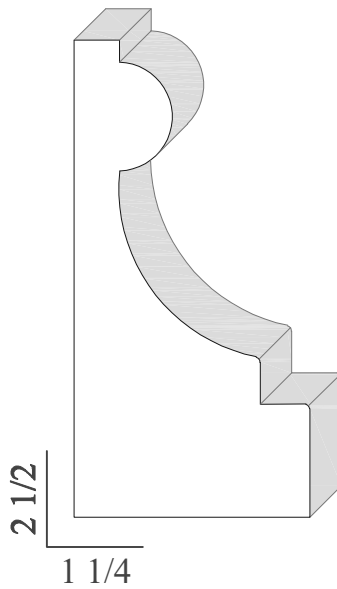

CTM | CA | 4007

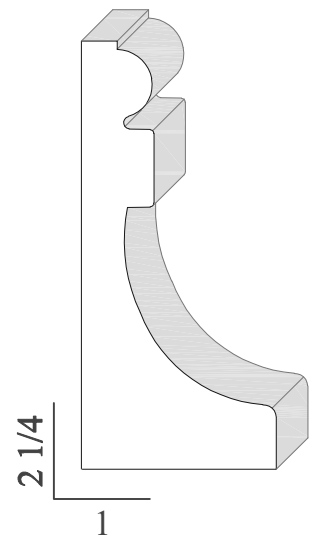

CTM | CA | 4008

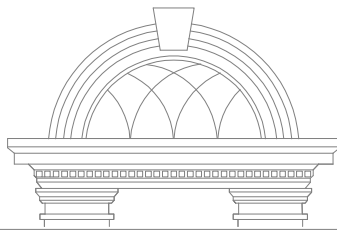

CT MOLDINGS

CASING

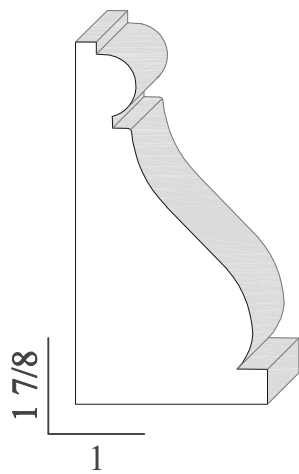

CTM | CA | 4009

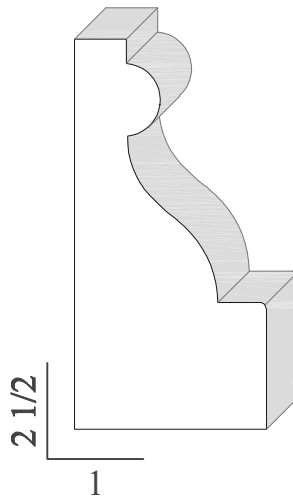

CTM | CA | 4010

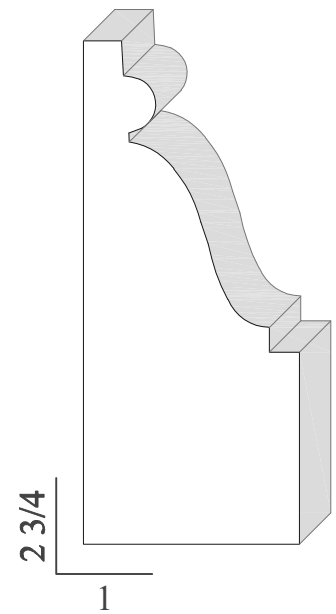

CTM | CA | 4011

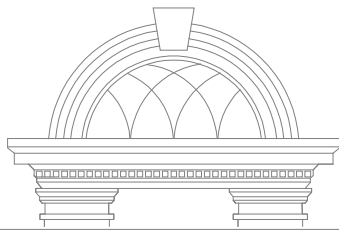

CT MOLDINGS

CASING

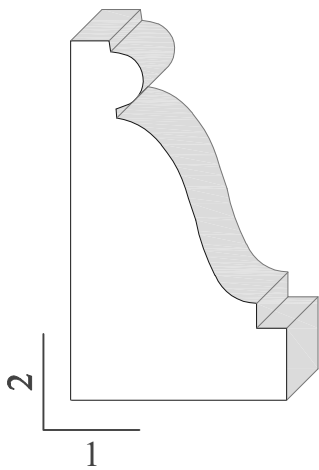

CTM | CA | 4012

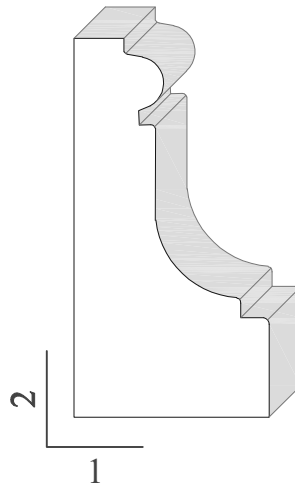

CTM | CA | 4013

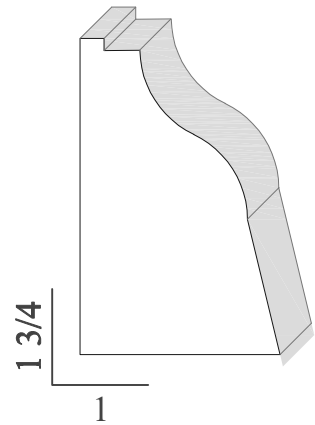

CTM | CA | 4014

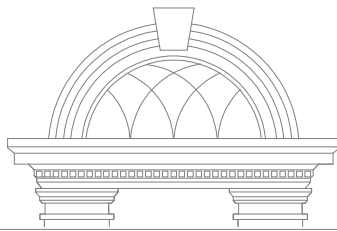

CT MOLDINGS

CASING

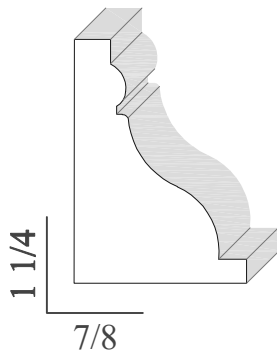

CTM | CA | 4015

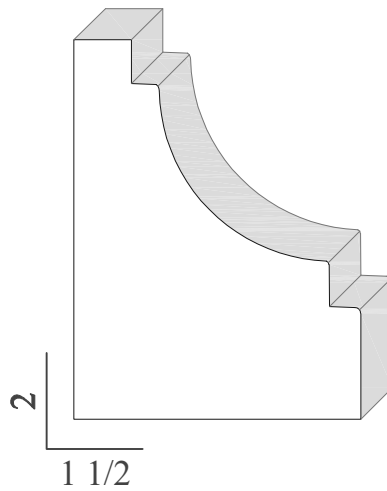

CTM | CA | 4016

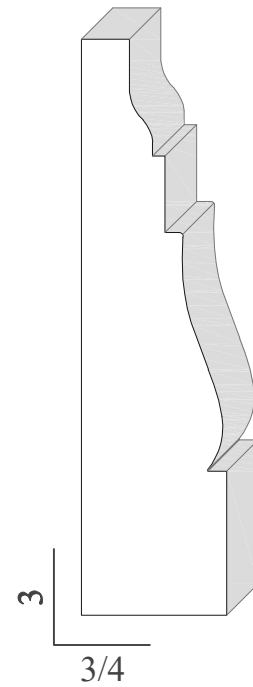

CTM | CA | 4017

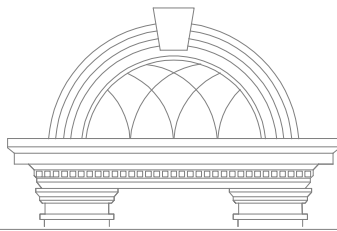

CT MOLDINGS

CASING

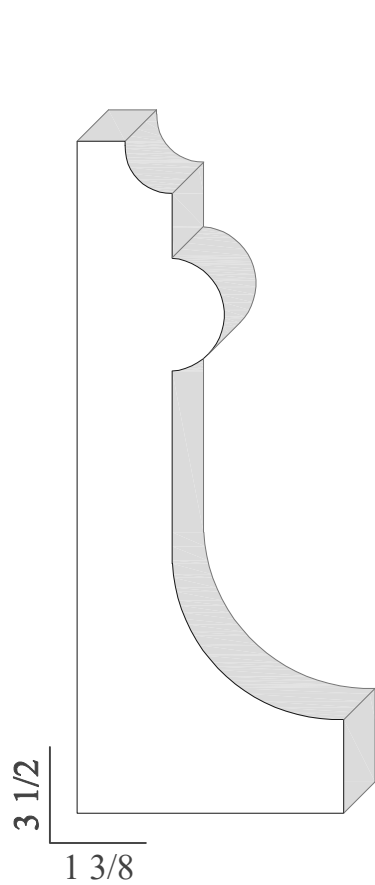

CTM | CA | 4018

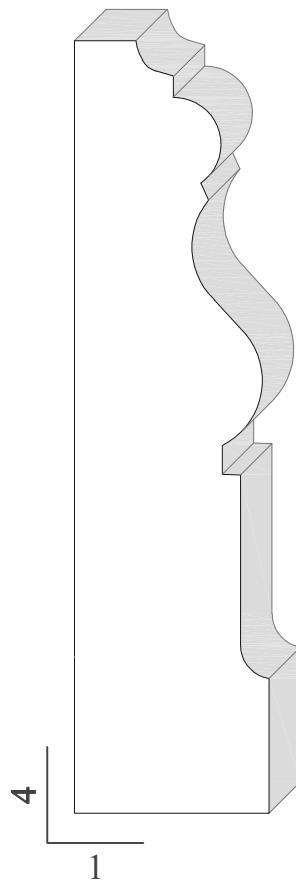

CTM | CA | 4019

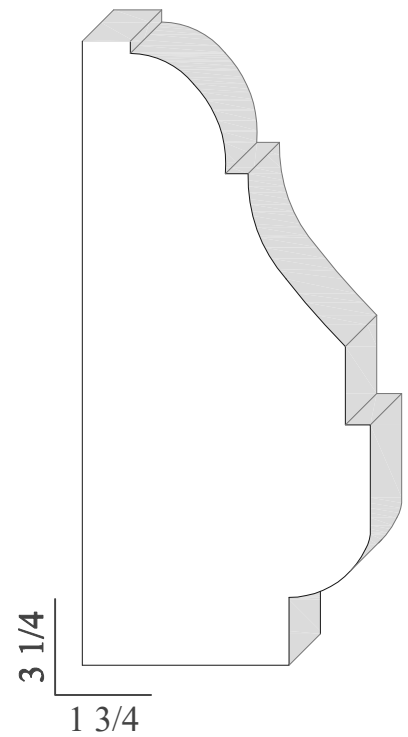

CTM | CA | 4019.1

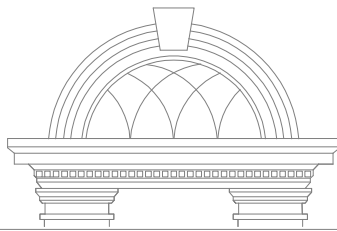

CT MOLDINGS

CASING

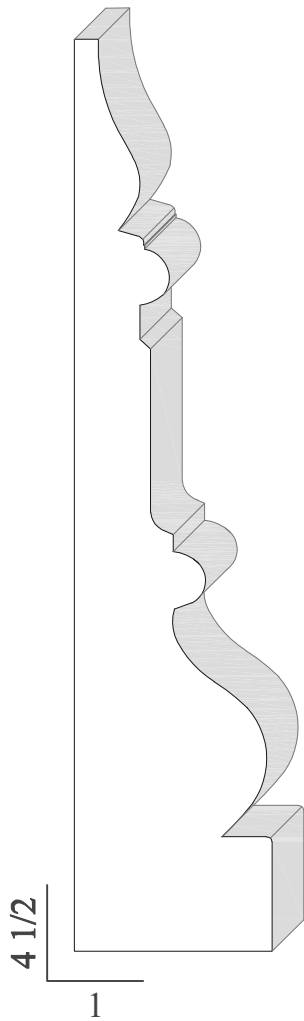

CTM | CA | 4020

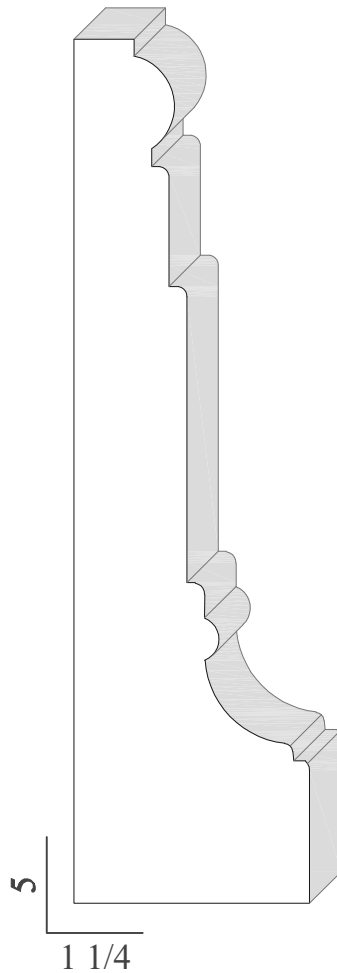

CTM | CA | 4021

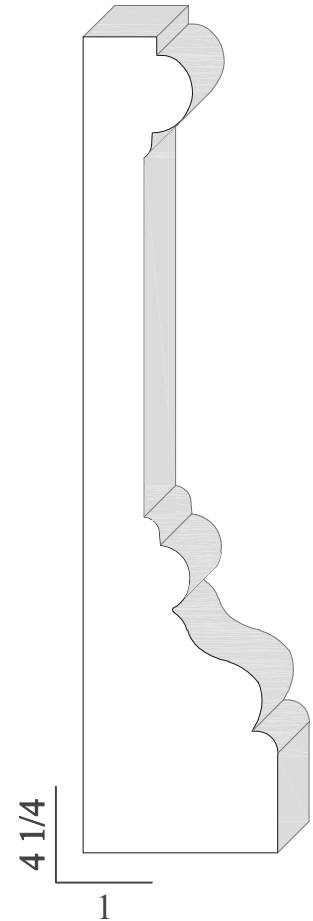

CTM | CA | 4022

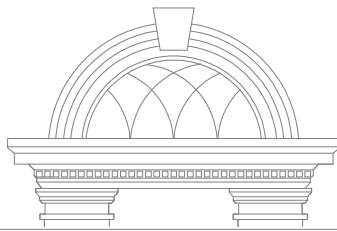

CT MOLDINGS

CASING

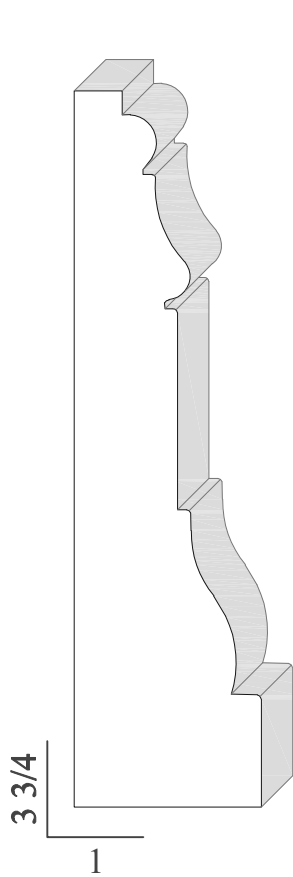

CTM | CA | 4023

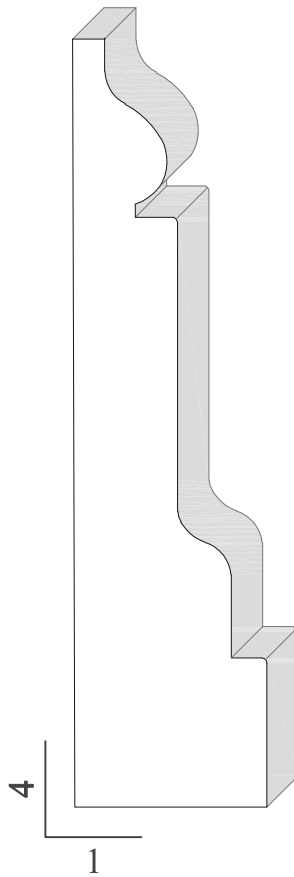

CTM | CA | 4024

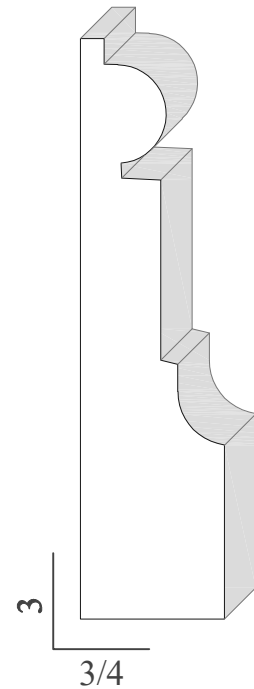

CTM | CA | 4025

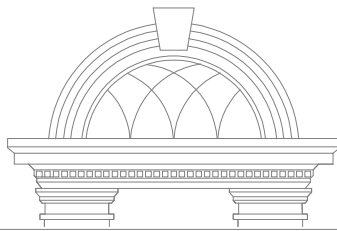

CT MOLDINGS

CASING

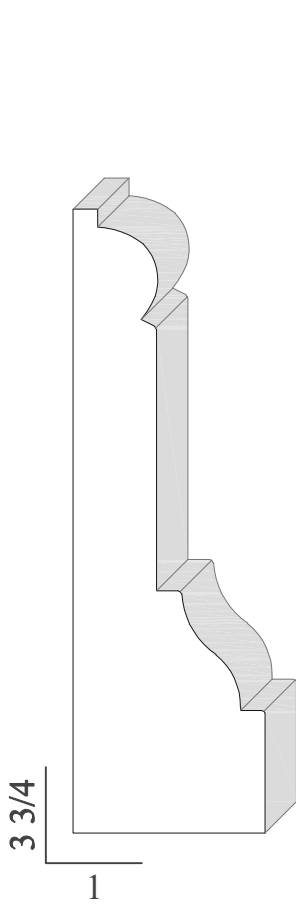

CTM | CA | 4025.1

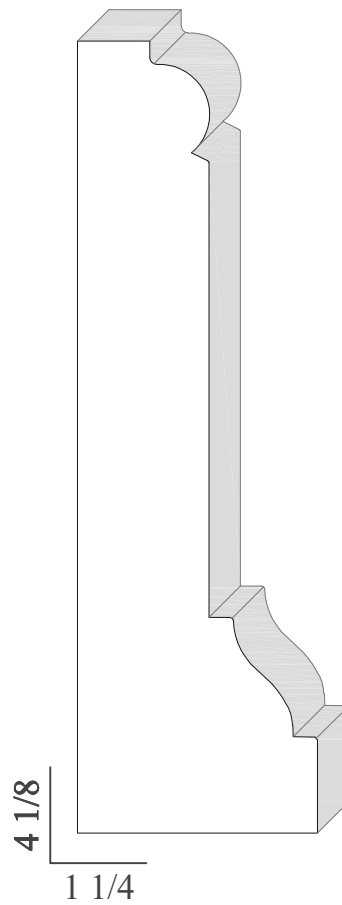

CTM | CA | 4025.2

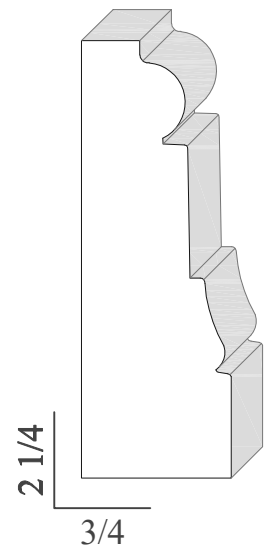

CTM | CA | 4026

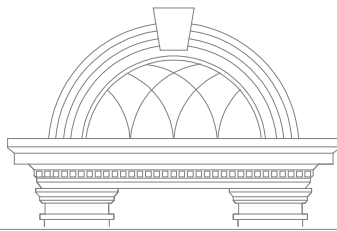

CT MOLDINGS

CASING

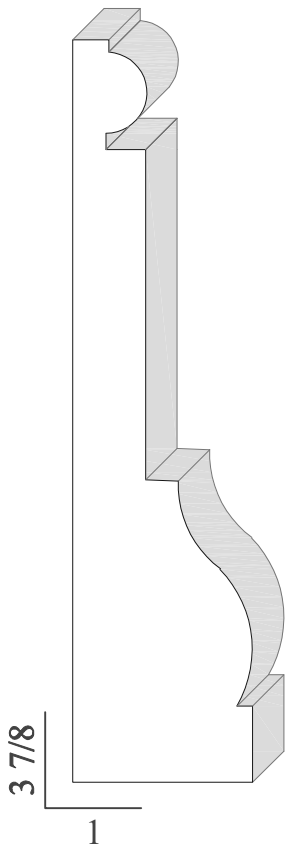

CTM | CA | 4027

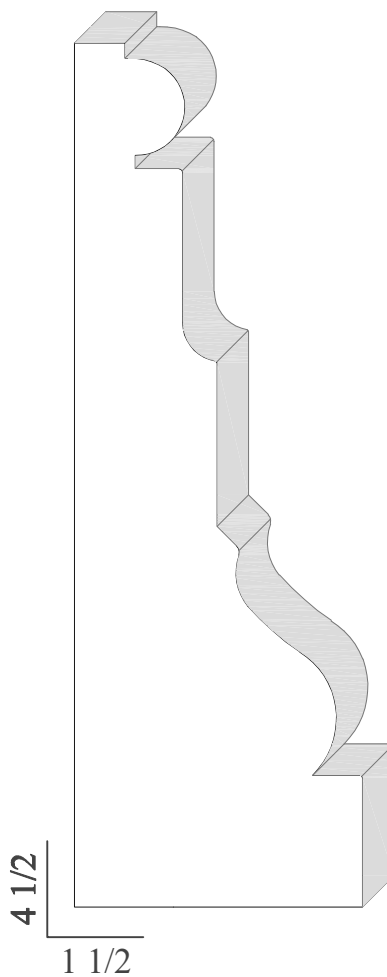

CTM | CA | 4027.1

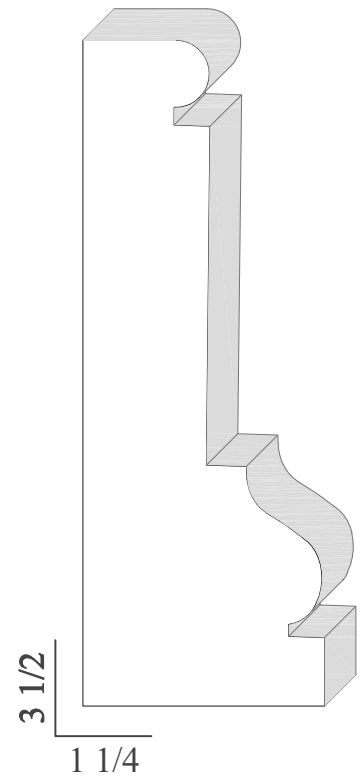

CTM | CA | 4028

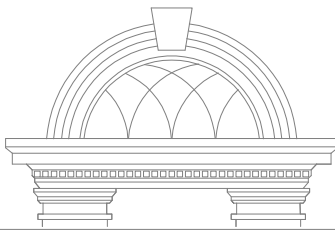

CT MOLDINGS

CASING

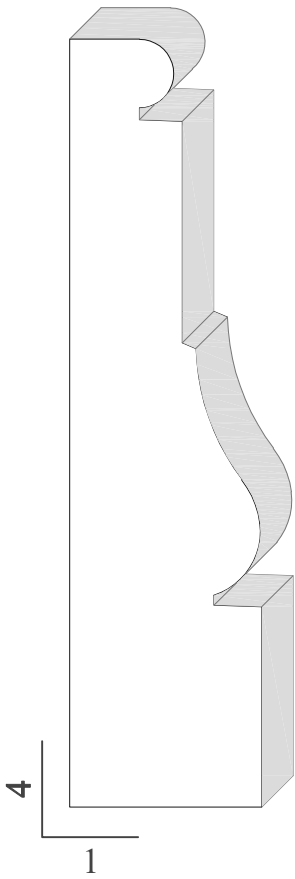

CTM | CA | 4029

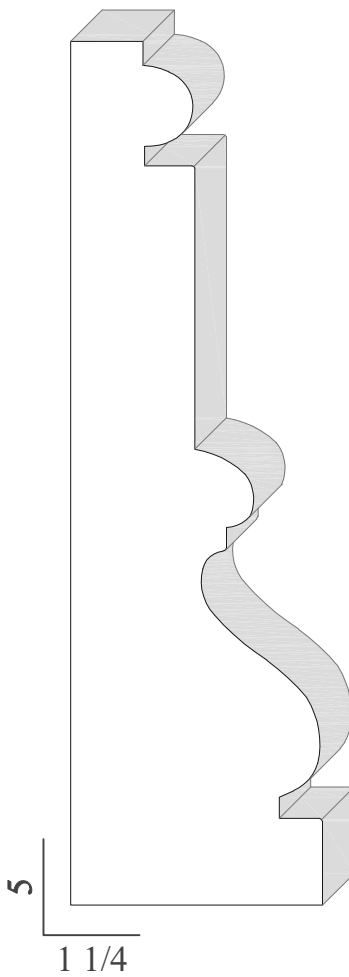

CTM | CA | 4030

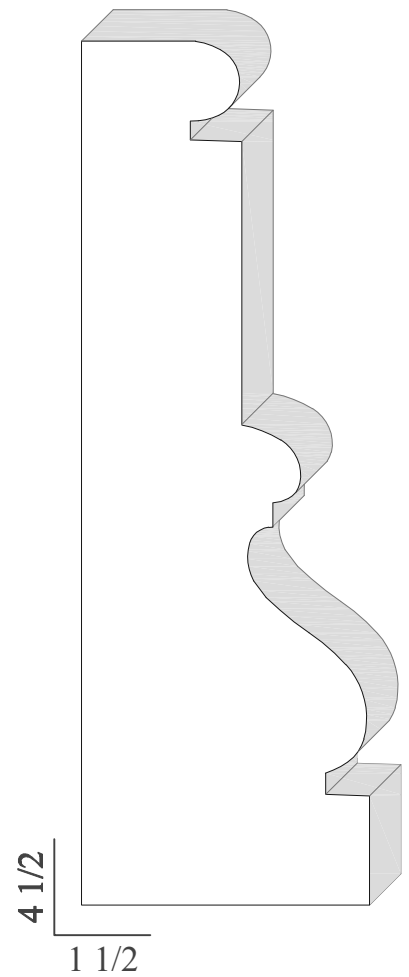

CTM | CA | 4031

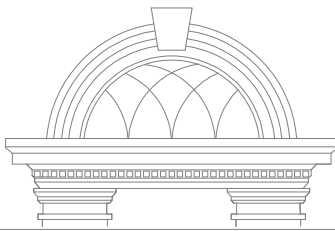

CT MOLDINGS

CASING

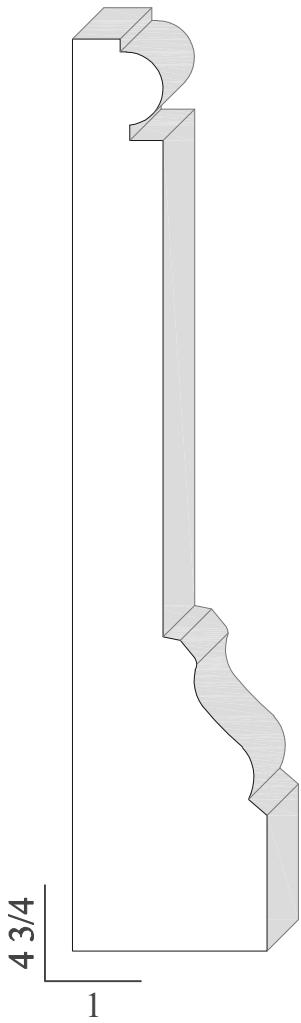

CTM | CA | 4032

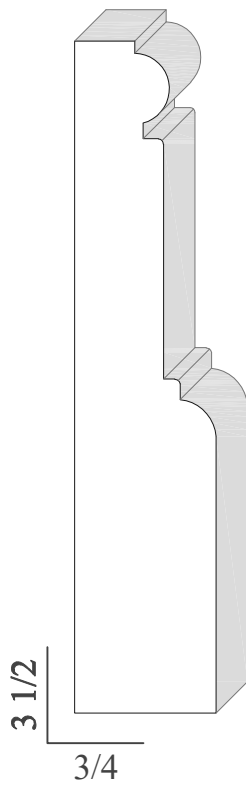

CTM | CA | 4033

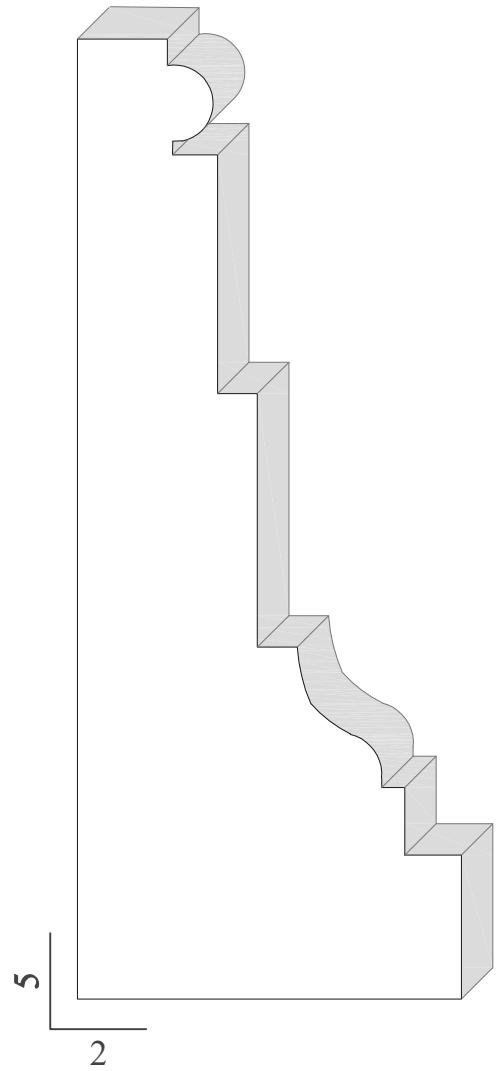

CTM | CA | 4033.1

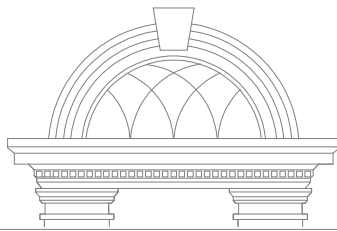

CT MOLDINGS

CASING

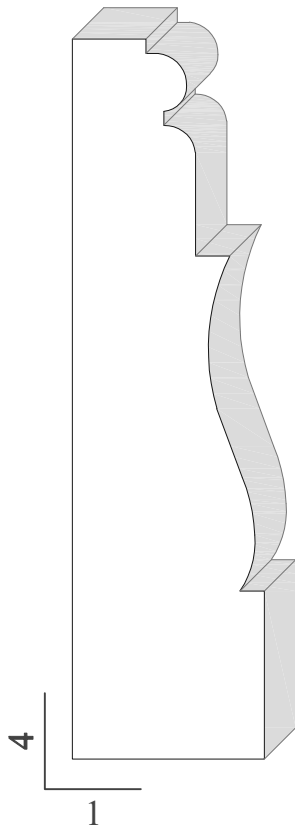

CTM | CA | 4033.2

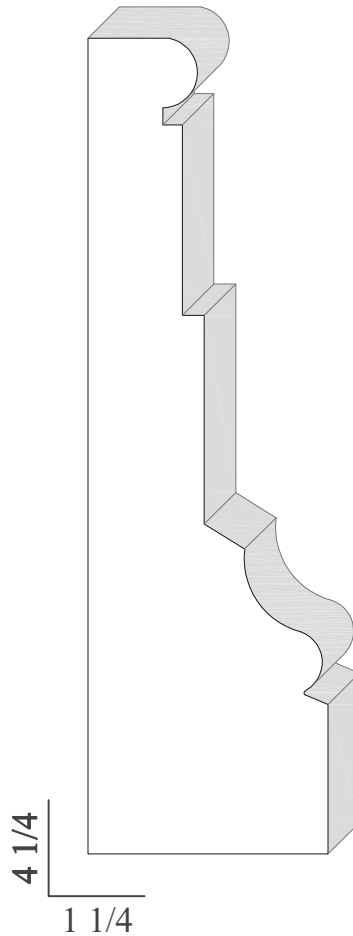

CTM | CA | 4034

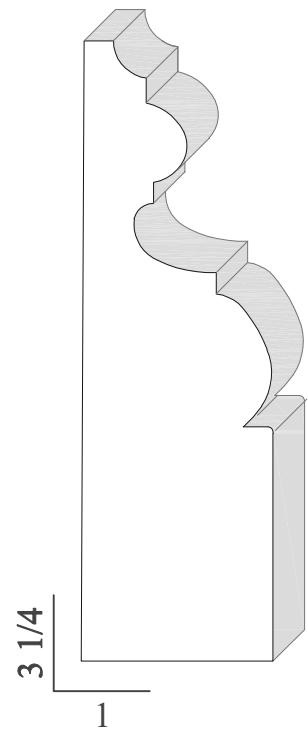

CTM | CA | 4035

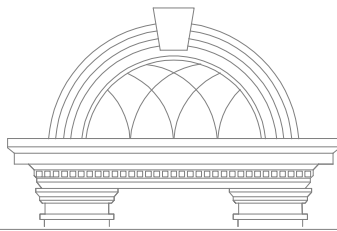

CT MOLDINGS

CASING

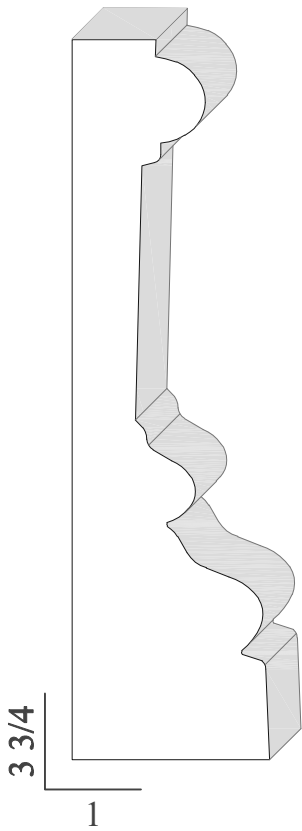

CTM | CA | 4036

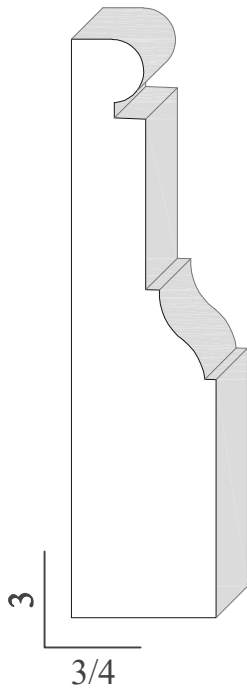

CTM | CA | 4037

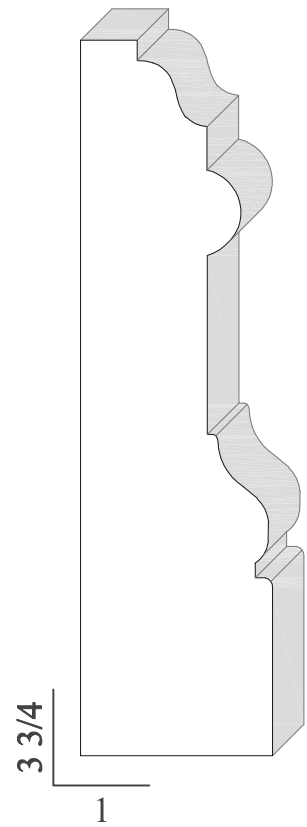

CTM | CA | 4038

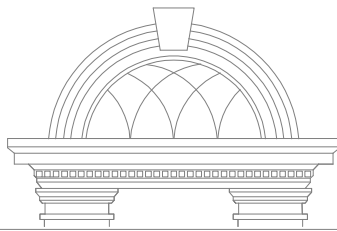

CT MOLDINGS

CASING

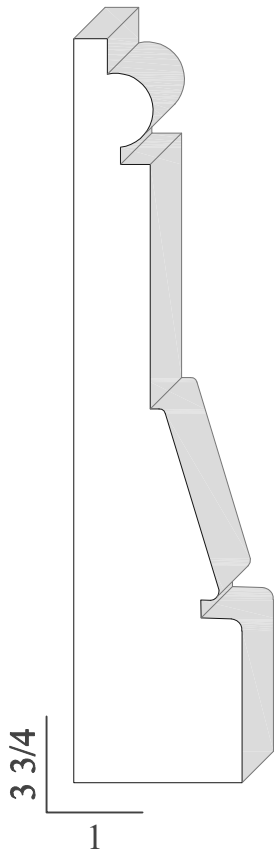

CTM | CA | 4039

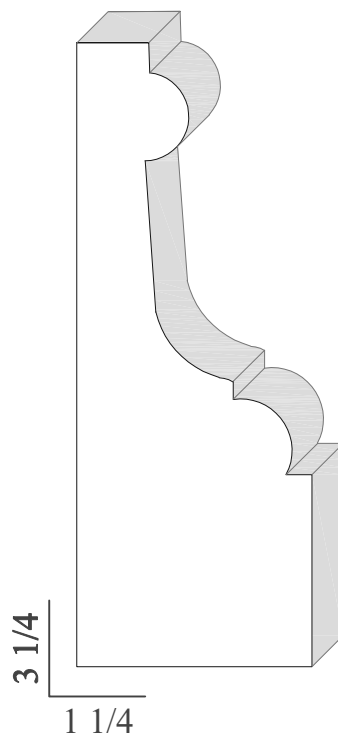

CTM | CA | 4040

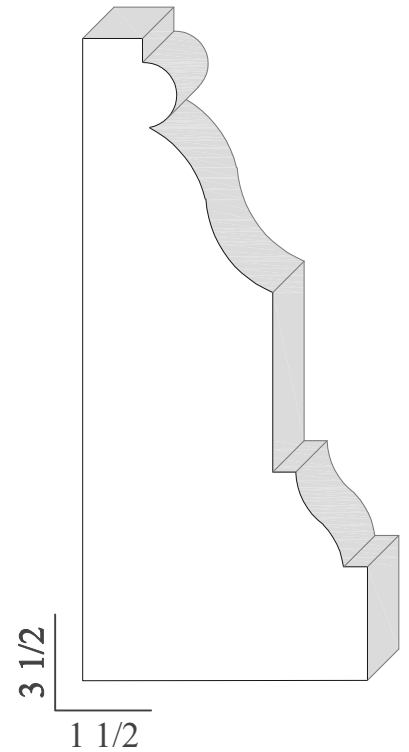

CTM | CA | 4041

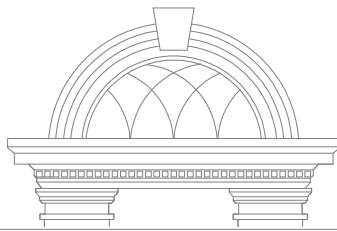

CT MOLDINGS

CASING

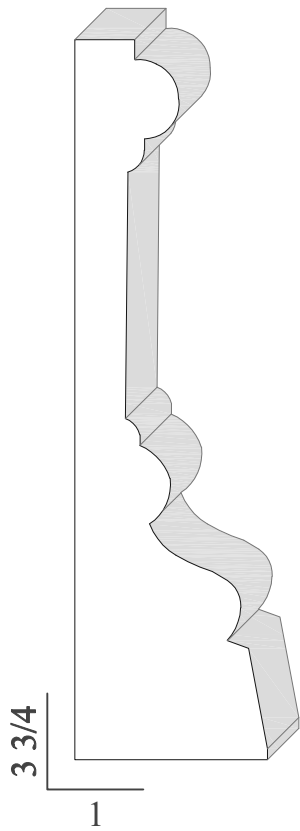

CTM | CA | 4042

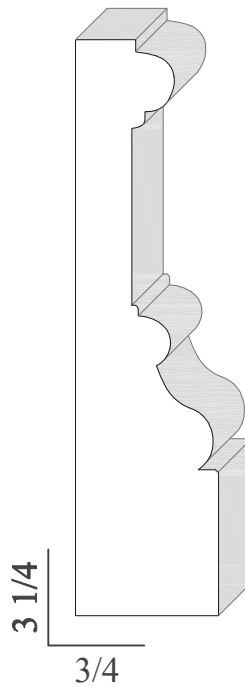

CTM | CA | 4043

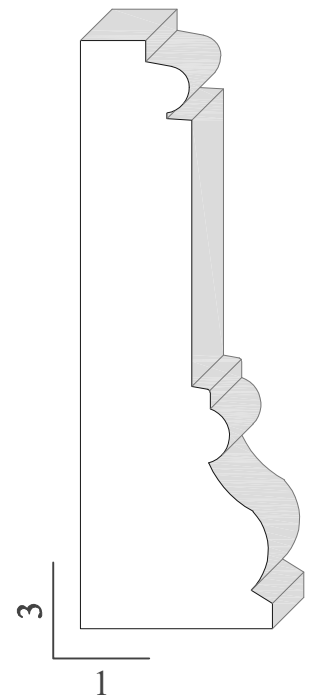

CTM | CA | 4044

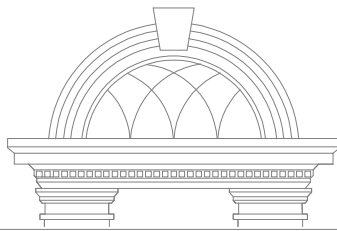

CT MOLDINGS

CASING

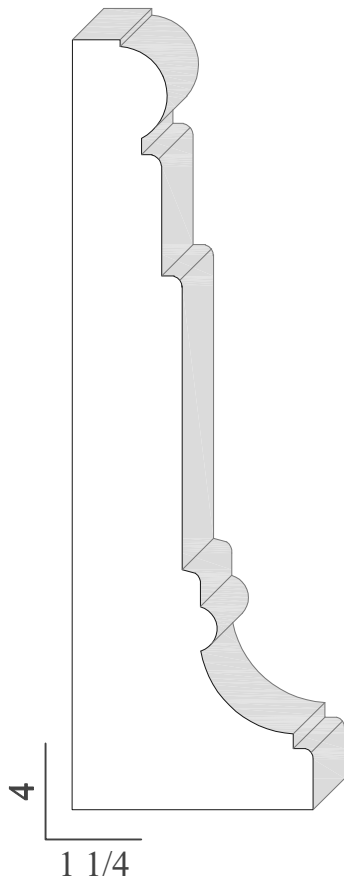

CTM | CA | 4045

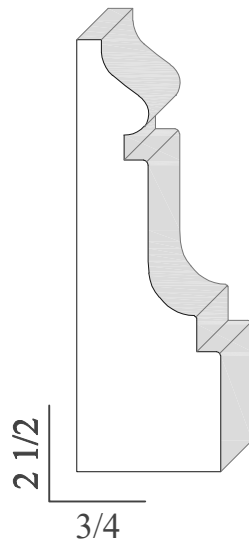

CTM | CA | 4045.1

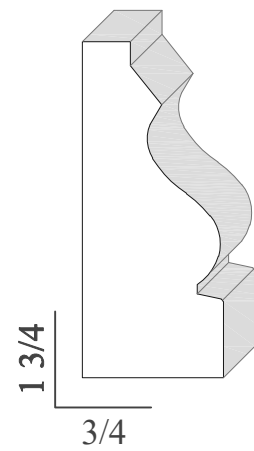

CTM | CA | 4045.2

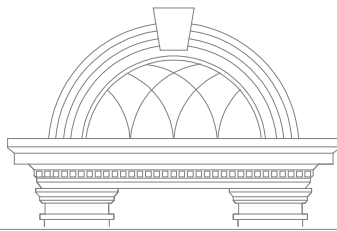

CT MOLDINGS

CASING

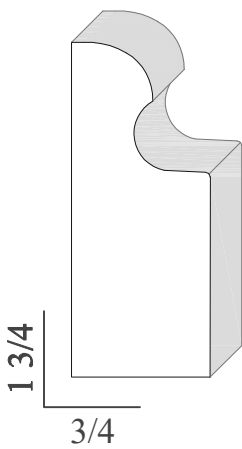

CTM | CA | 4046

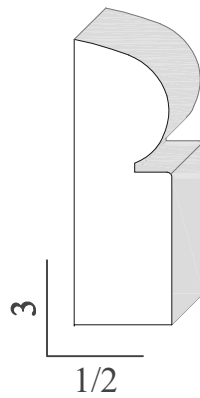

CTM | CA | 4047

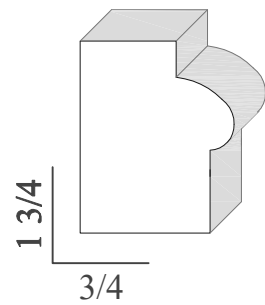

CTM | CA | 4047.1

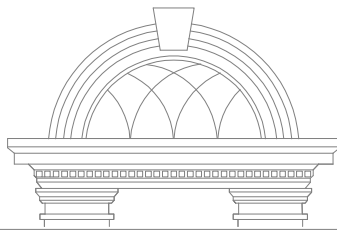

CT MOLDINGS

CASING

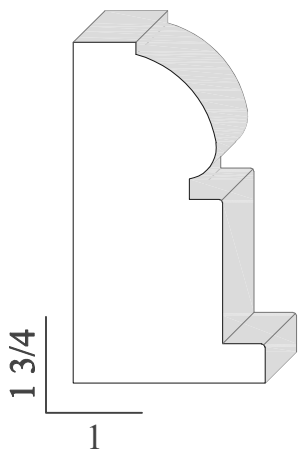

CTM | CA | 4048

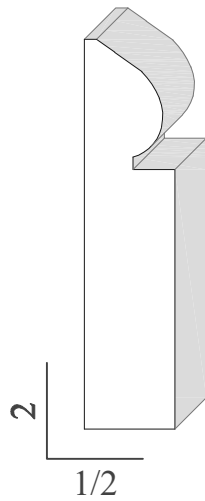

CTM | CA | 4049

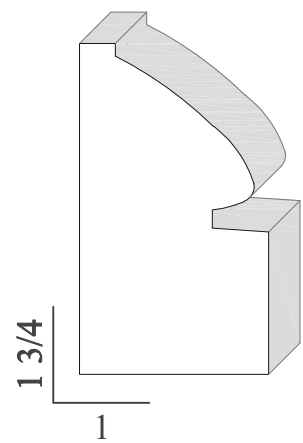

CTM | CA | 4050

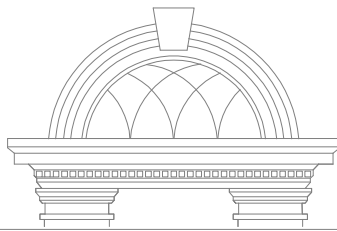

CT MOLDINGS

CASING

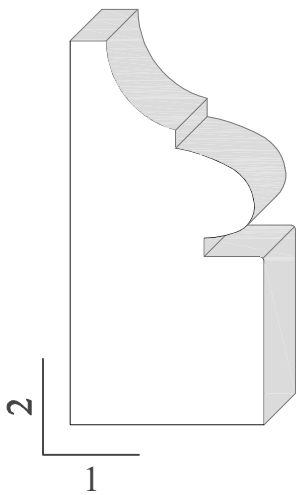

CTM | CA | 4051

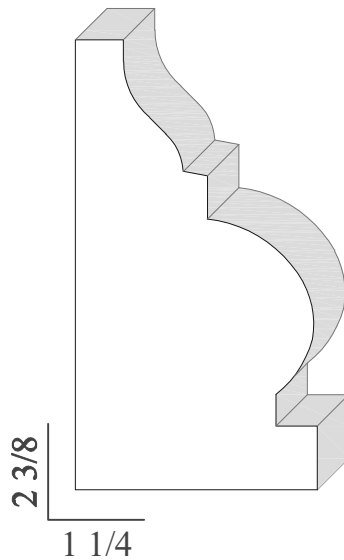

CTM | CA | 4052

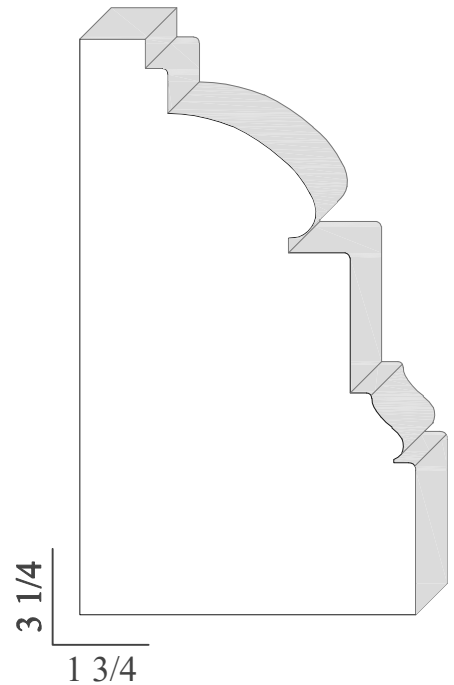

CTM | CA | 4053

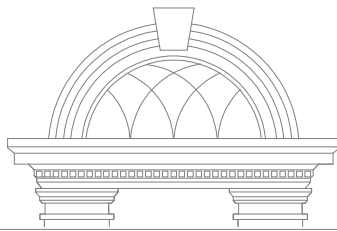

CT MOLDINGS

CASING

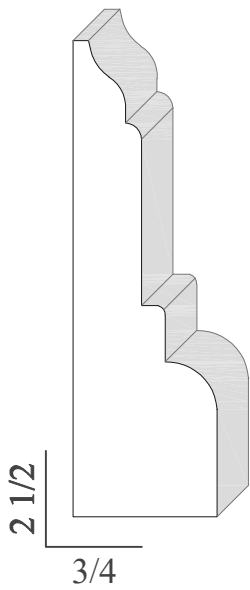

CTM | CA | 4054

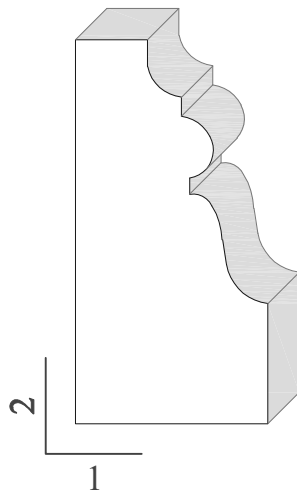

CTM | CA | 4055

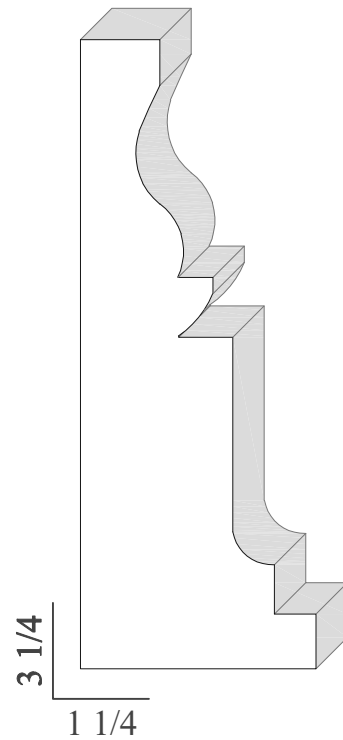

CTM | CA | 4057

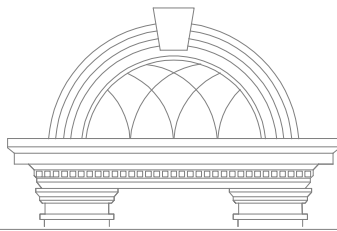

CT MOLDINGS

CASING

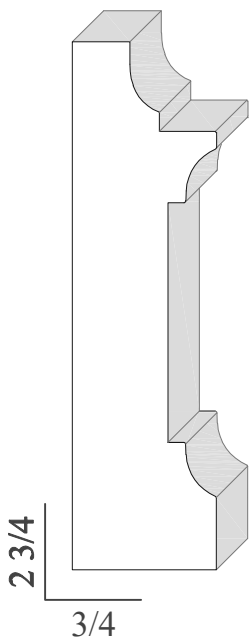

CTM | CA | 4057.1

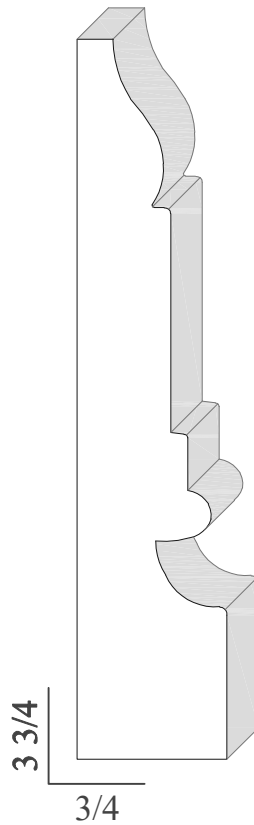

CTM | CA | 4058

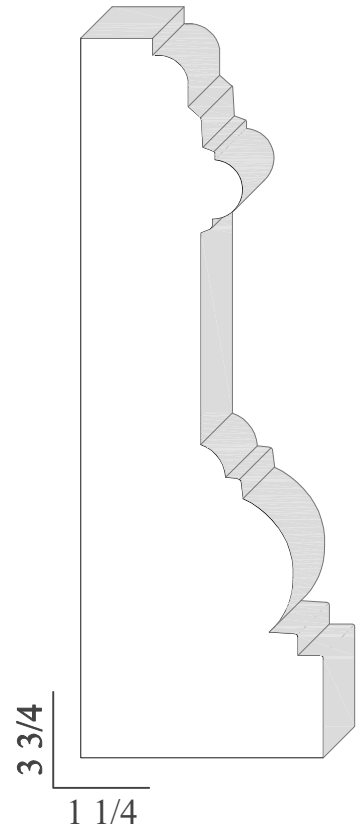

CTM | CA | 4059

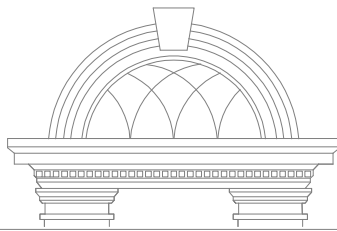

CT MOLDINGS

CASING

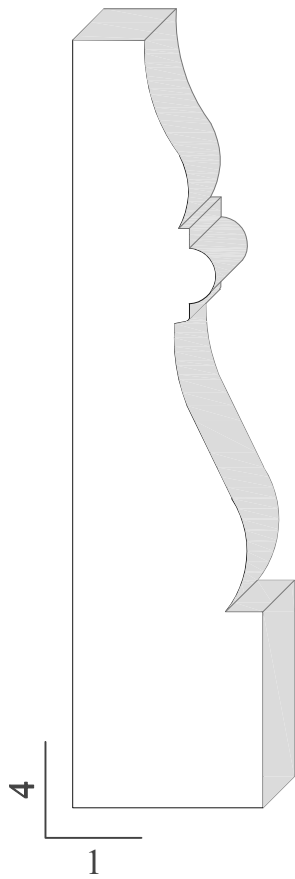

CTM | CA | 4060

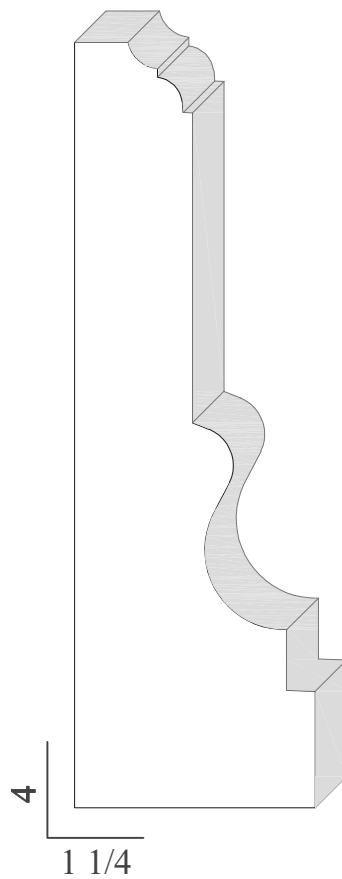

CTM | CA | 4061

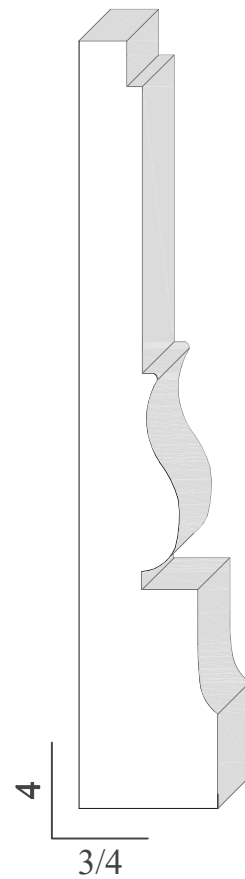

CTM | CA | 4062

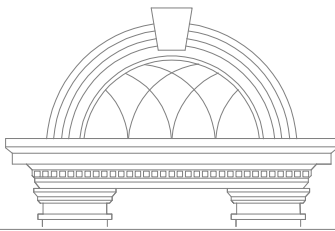

CT MOLDINGS

CASING

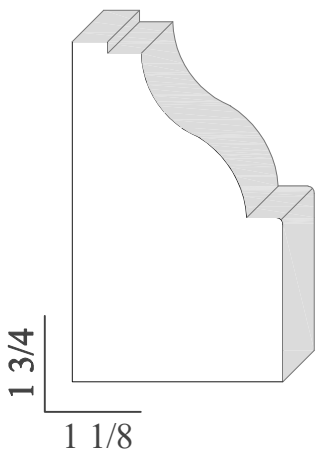

CTM | CA | 4063

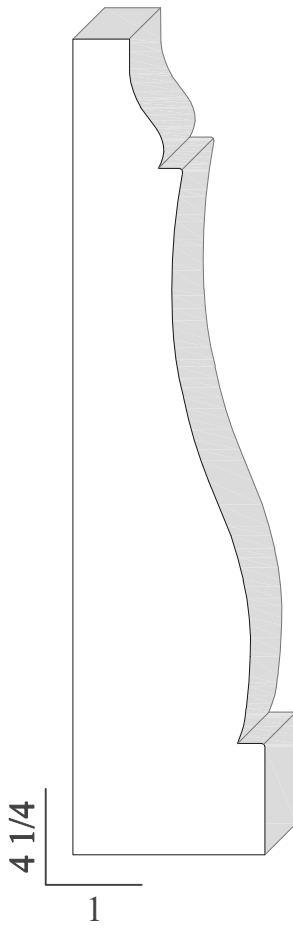

CTM | CA | 4064

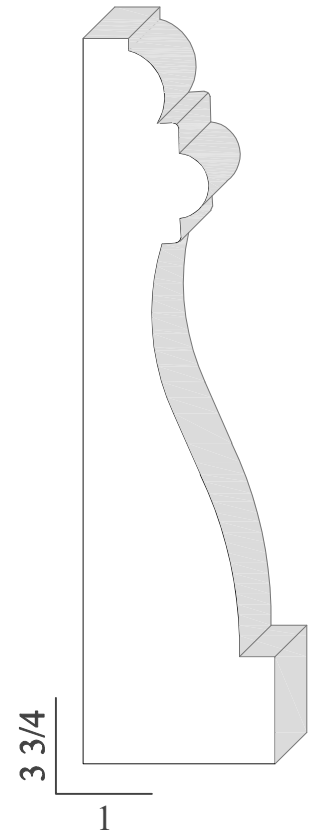

CTM | CA | 4065

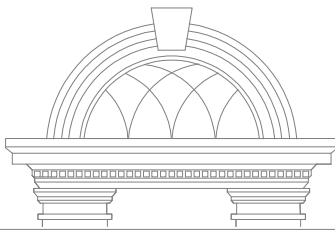

CT MOLDINGS

CASING

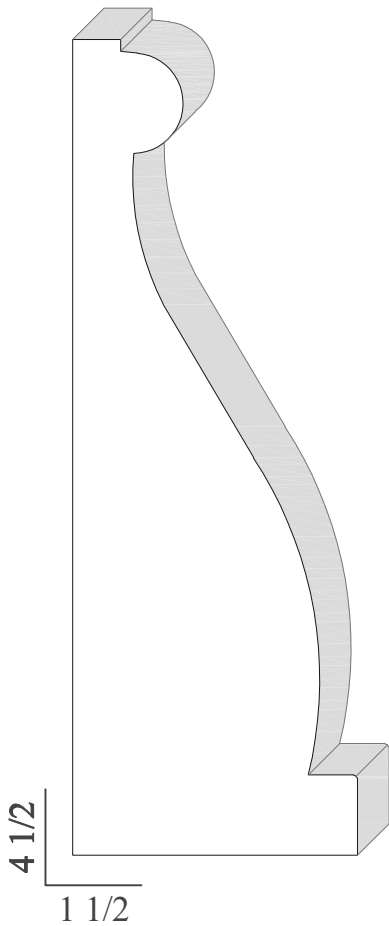

CTM | CA | 4066

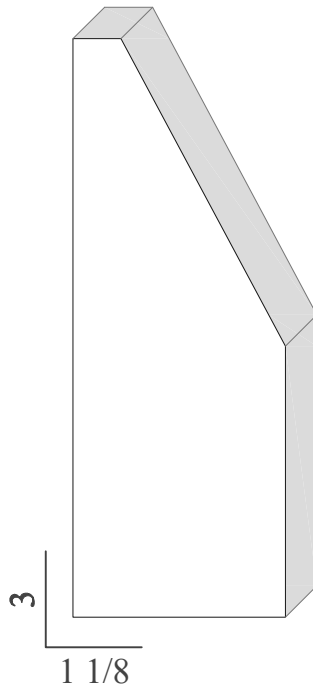

CTM | CA | 4067

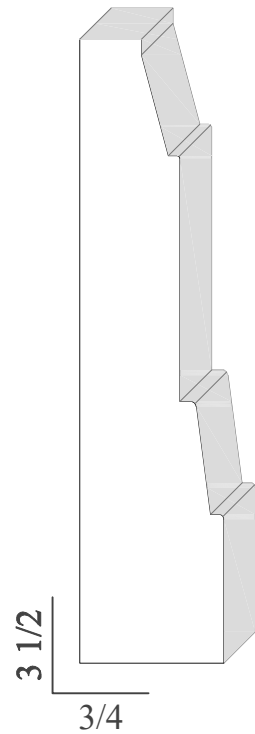

CTM | CA | 4067.1

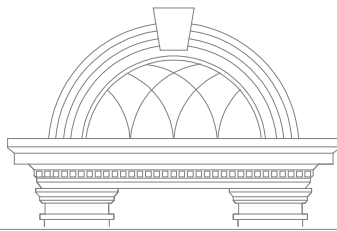

CT MOLDINGS

CASING

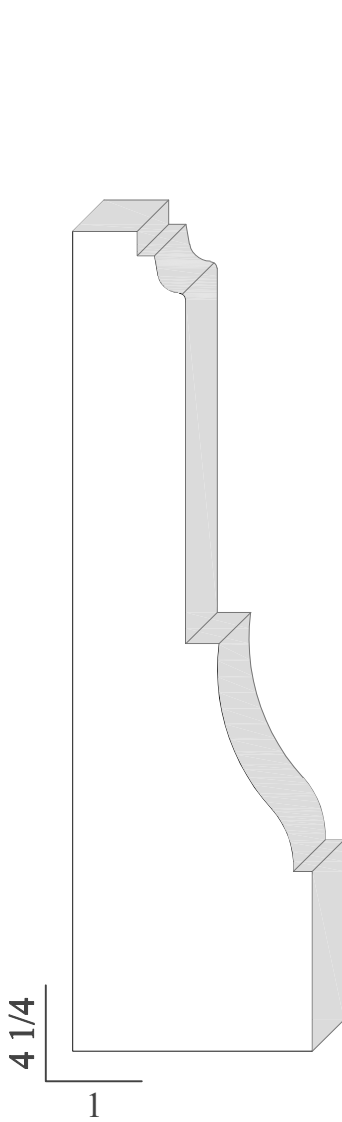

CTM | CA | 4068

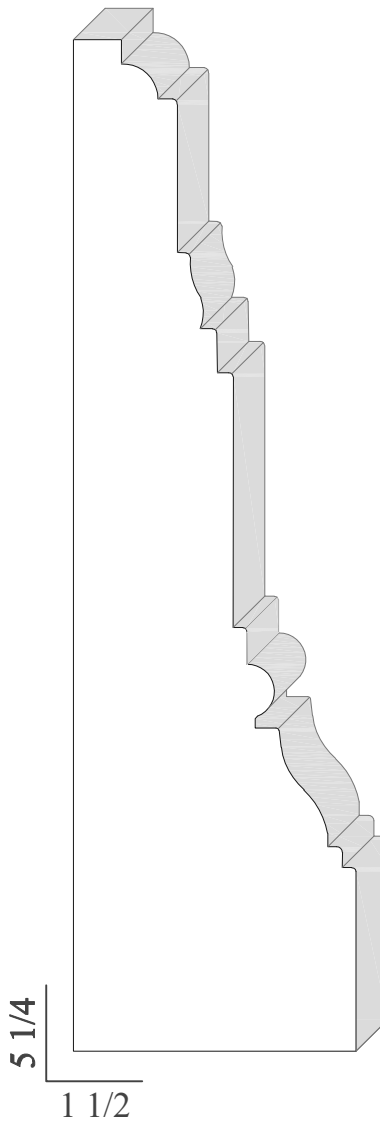

CTM | CA | 4069

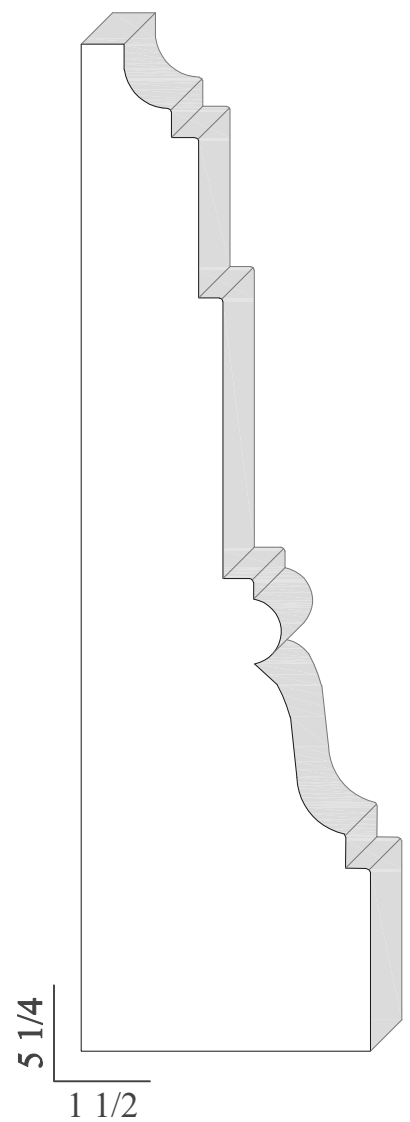

CTM | CA | 4070

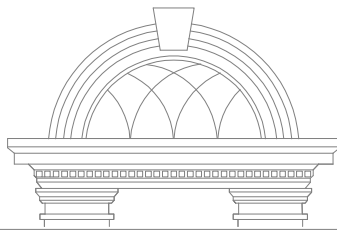

CT MOLDINGS

CASING

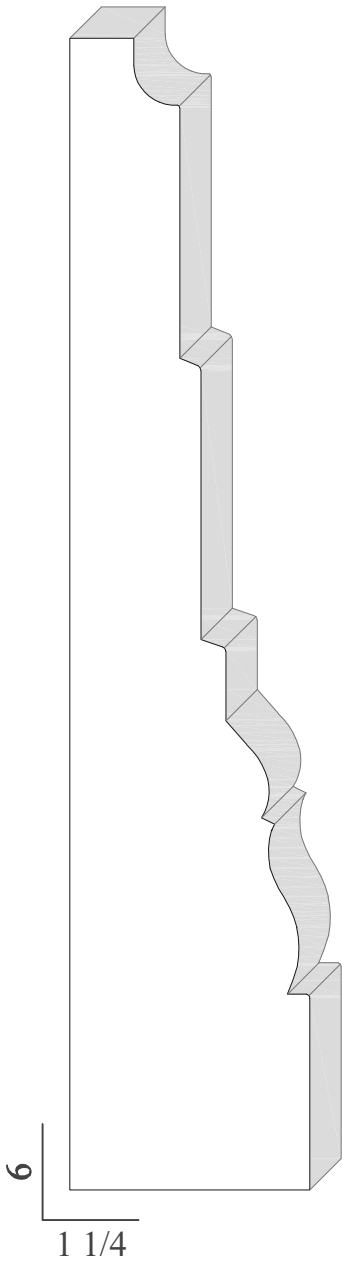

CTM | CA | 4070.1

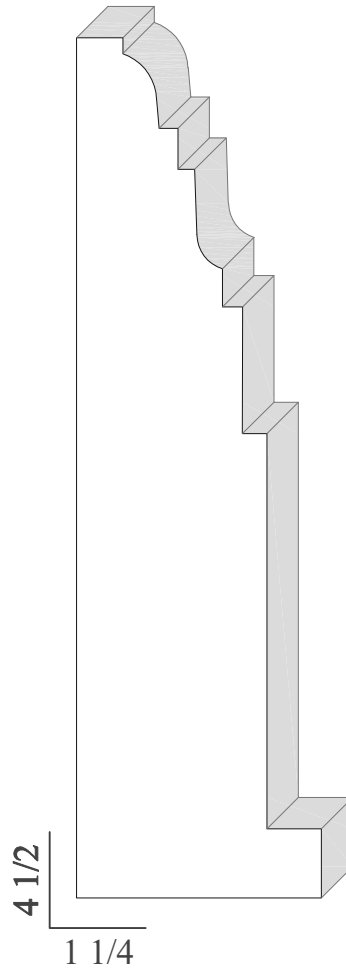

CTM | CA | 4071

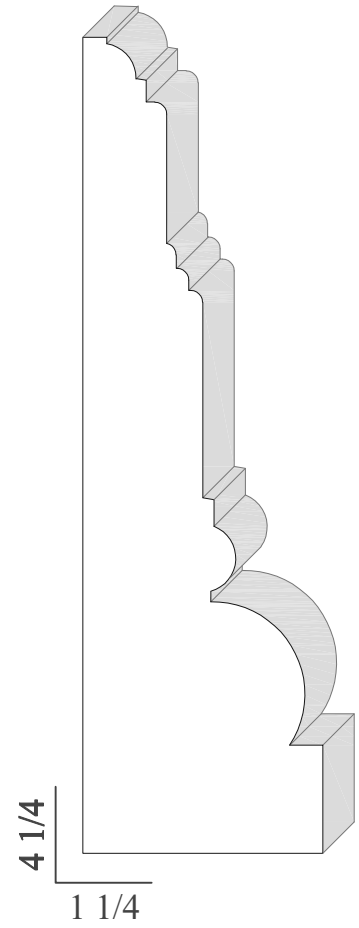

CTM | CA | 4072

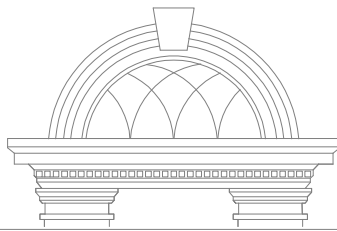

CT MOLDINGS

CASING

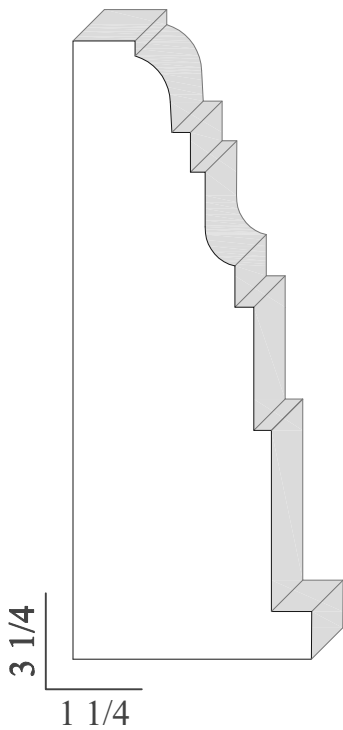

CTM | CA | 4073

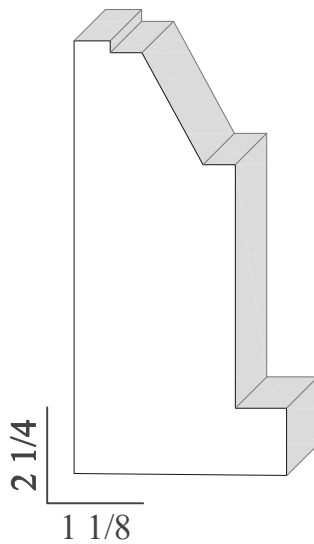

CTM | CA | 4074

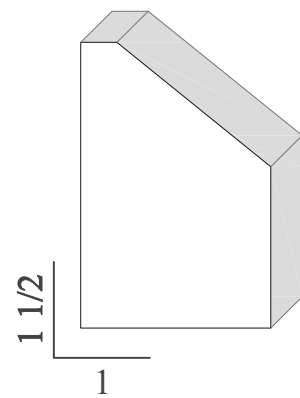

CTM | CA | 4075

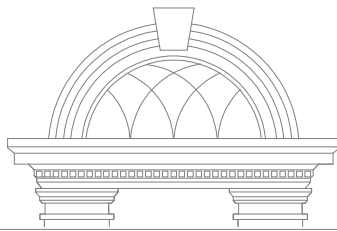

CT MOLDINGS

CASING

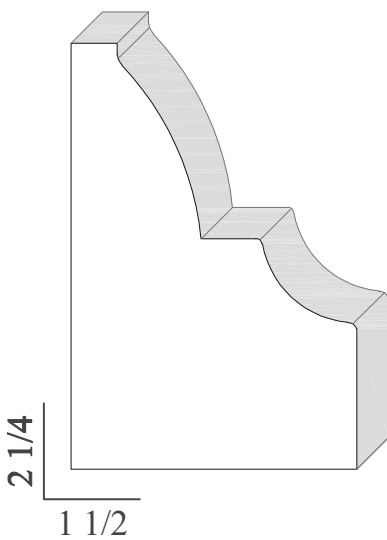

CTM | CA | 4076

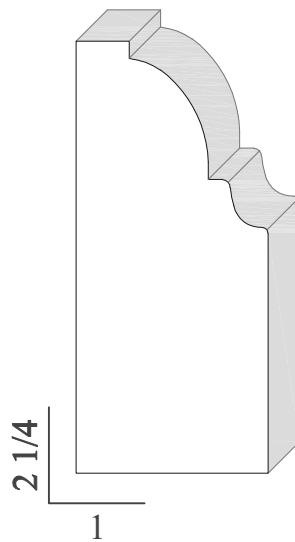

CTM | CA | 4078

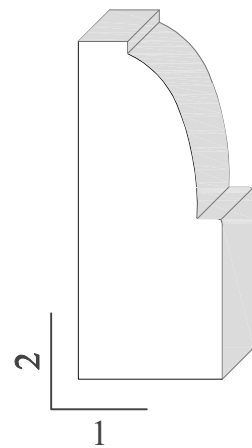

CTM | CA | 4079

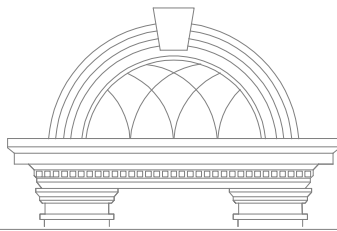

CT MOLDINGS

CASING

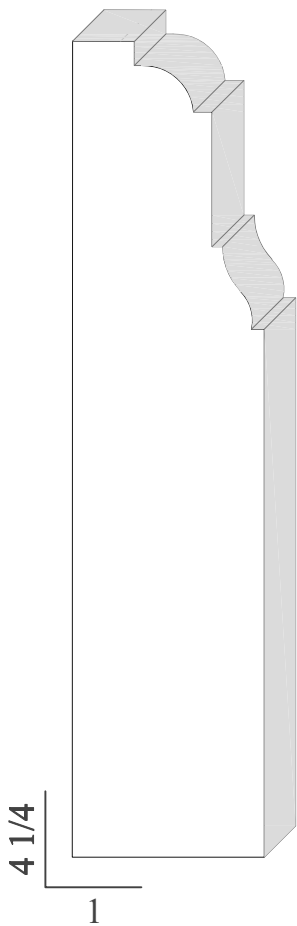

CTM | CA | 4080

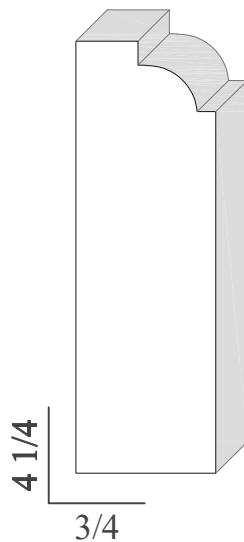

CTM | CA | 4081

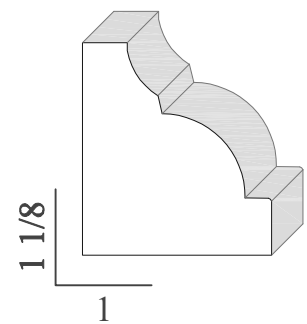

CTM | CA | 4082

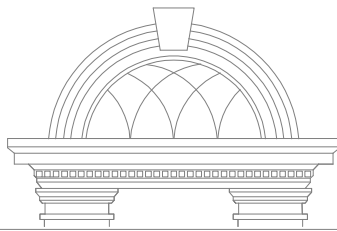

CT MOLDINGS

CASING

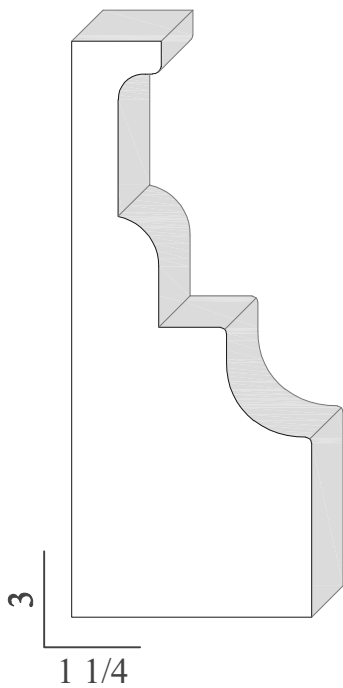

CTM | CA | 4082.1

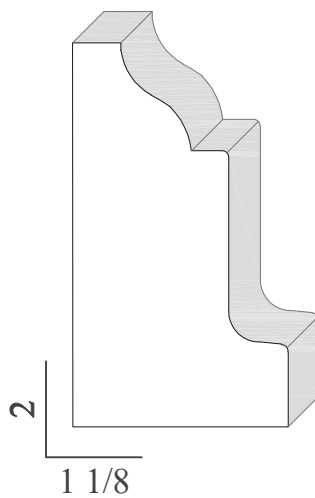

CTM | CA | 4083

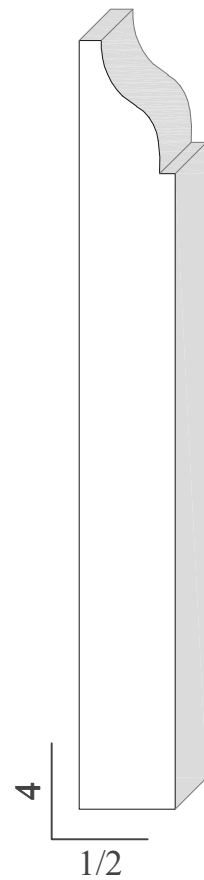

CTM | CA | 4084

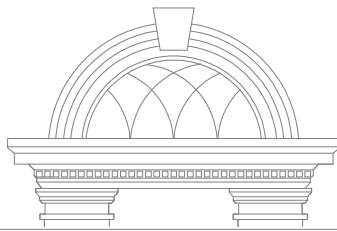

CT MOLDINGS

CASING

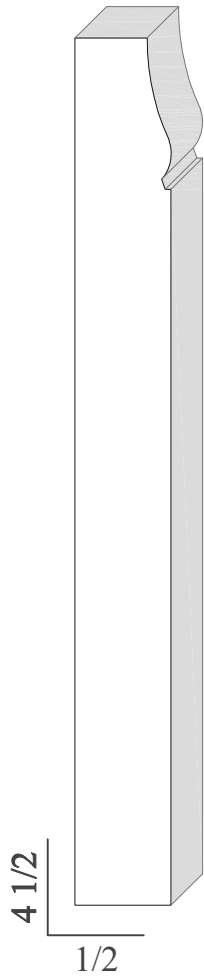

CTM | CA | 4085

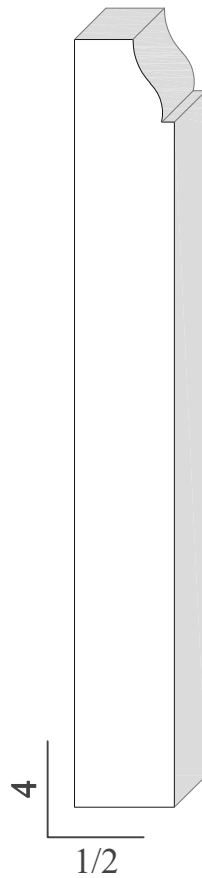

CTM | CA | 4086

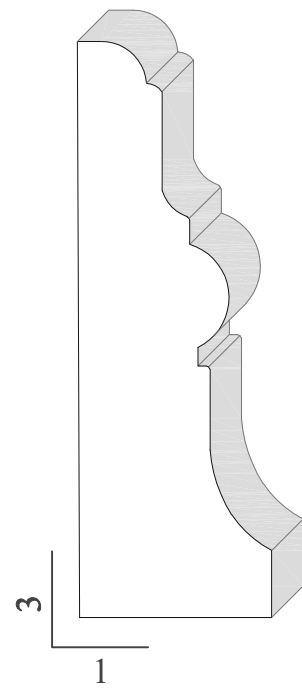

CTM | CA | 4087

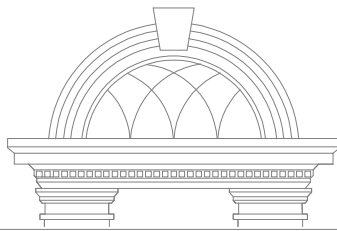

CT MOLDINGS

CASING

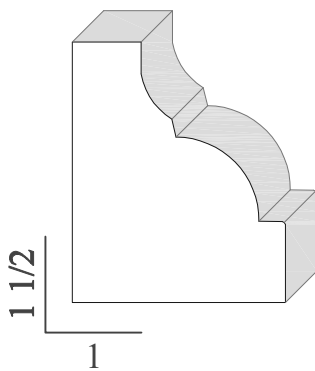

CTM | CA | 4088

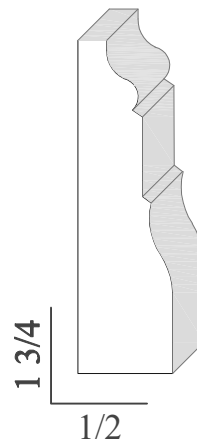

CTM | CA | 4090

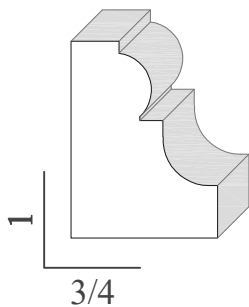

CTM | CA | 4089

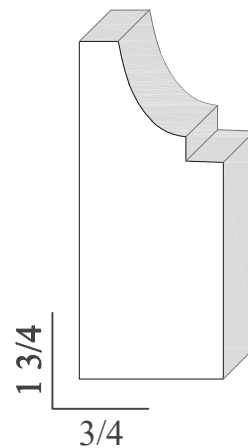

CTM | CA | 4091

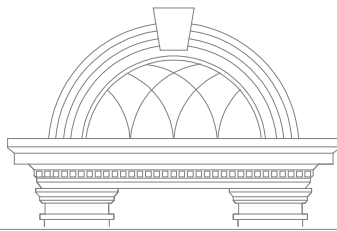

CT MOLDINGS

CASING

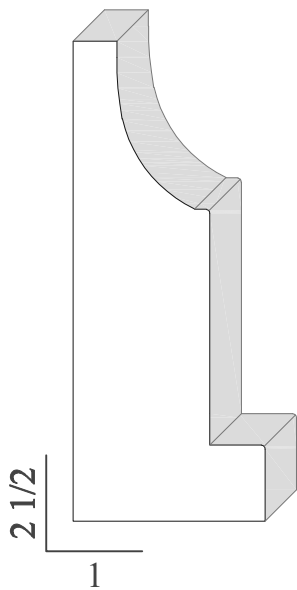

CTM | CA | 4091.1

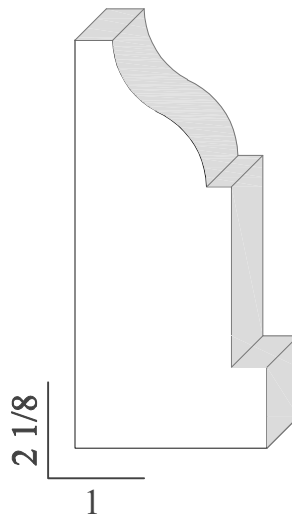

CTM | CA | 4092

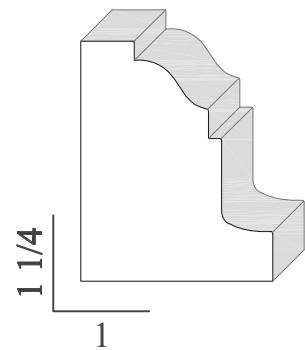

CTM | CA | 4092.1

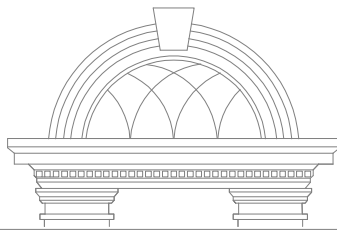

CT MOLDINGS

CASING

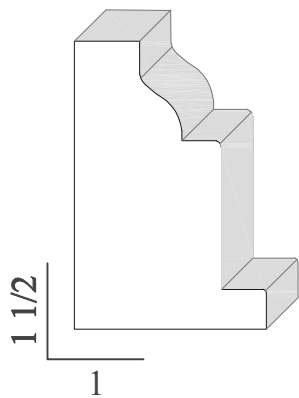

CTM | CA | 4092.2

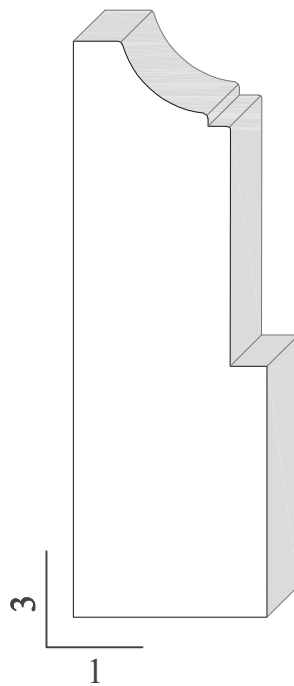

CTM | CA | 4093

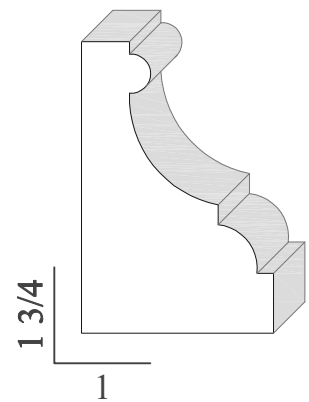

CTM | CA | 4094

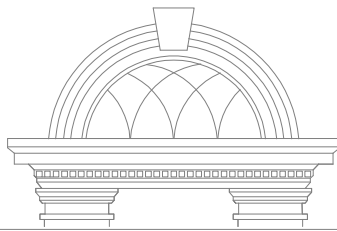

CT MOLDINGS

CASING

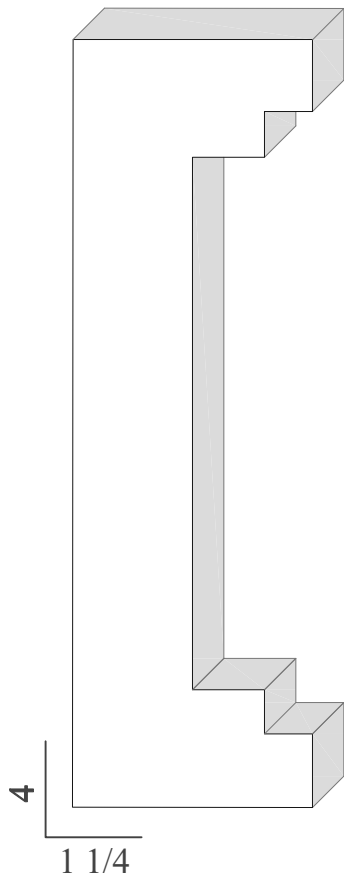

CTM | CA | 4095

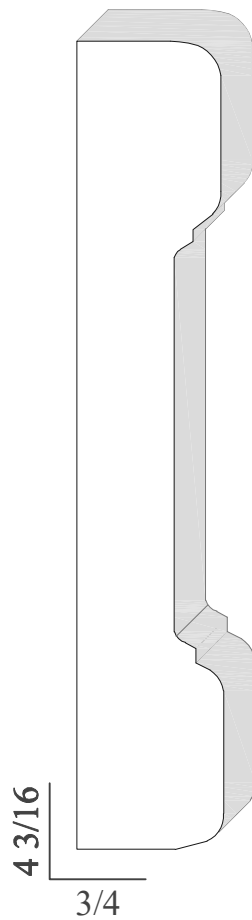

CTM | CA | 4096

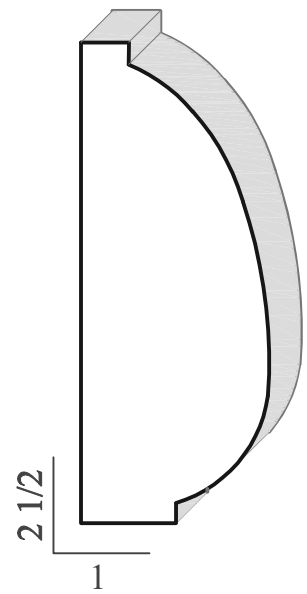

CTM | CA | 4097

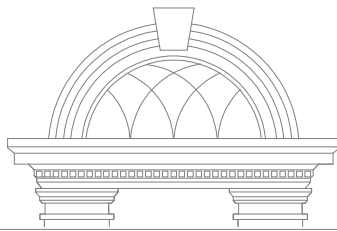

CT MOLDINGS

CASING

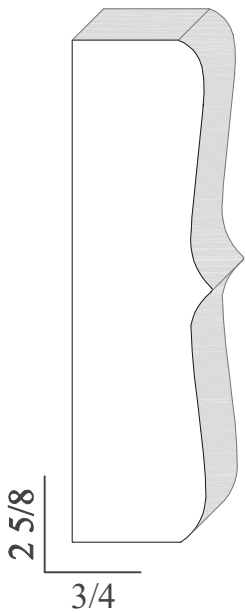

CTM | CA | 4098

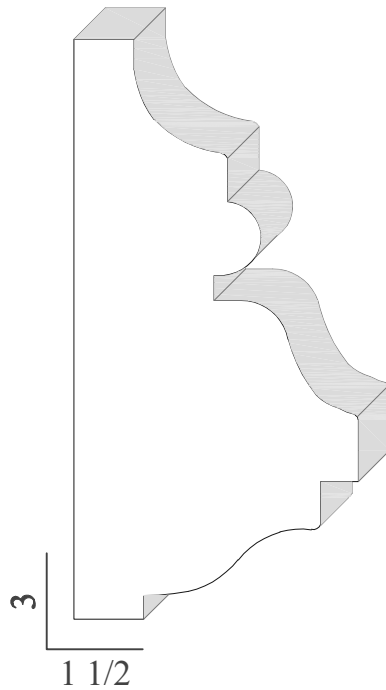

CTM | CA | 4099

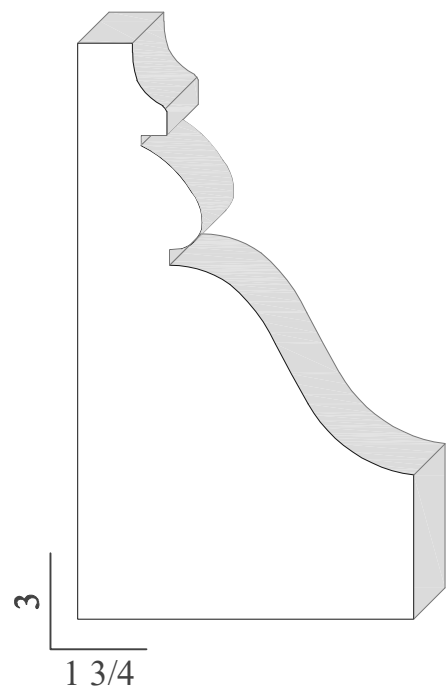

CTM | CA | 4099.1

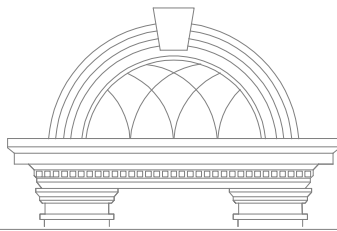

CT MOLDINGS

CASING

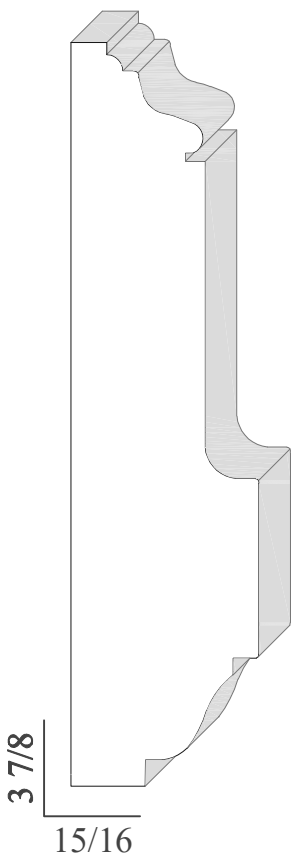

CTM | CA | 4100

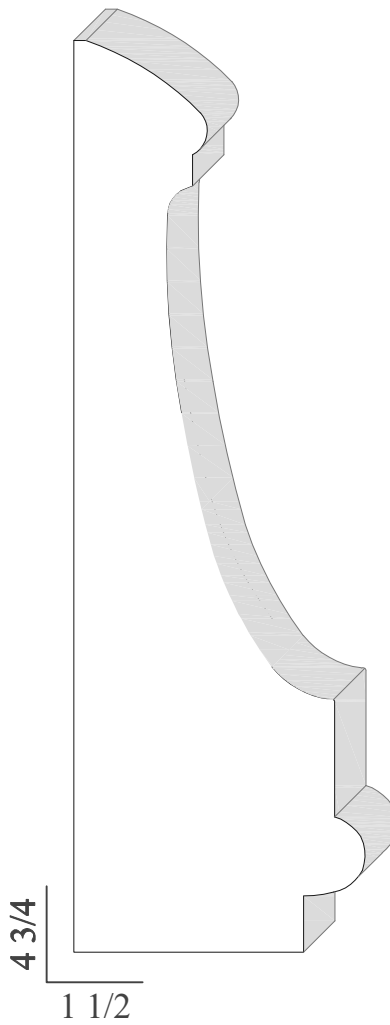

CTM | CA | 4101

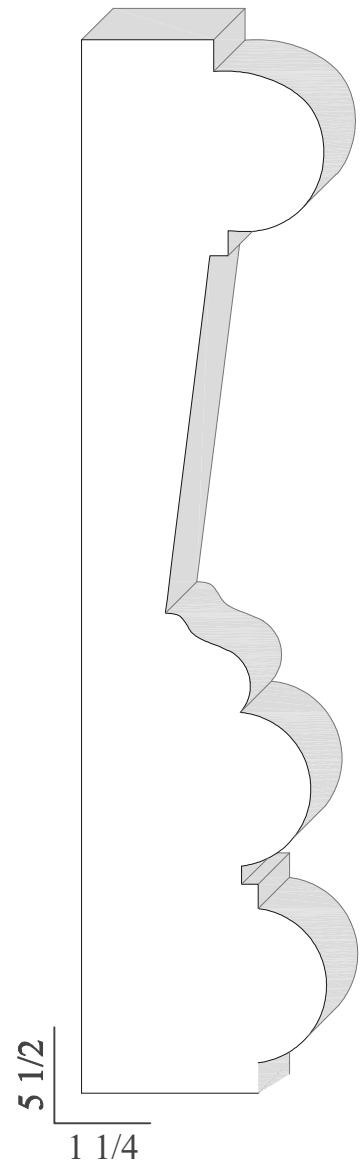

CTM | CA | 4102

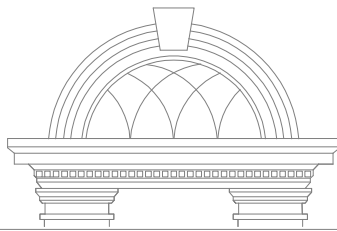

CT MOLDINGS

CASING

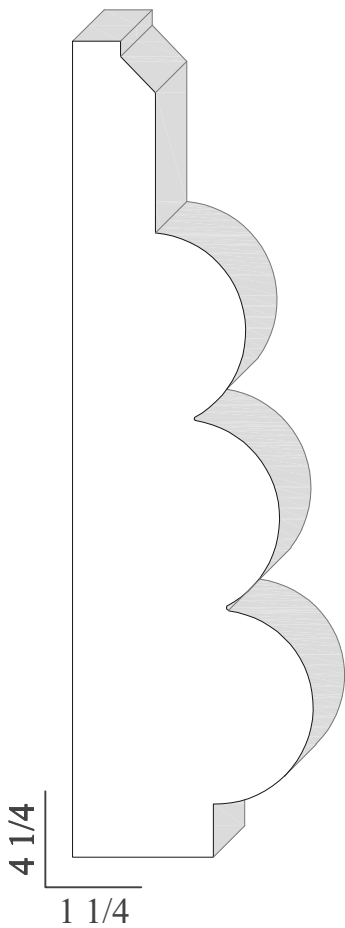

CTM | CA | 4103

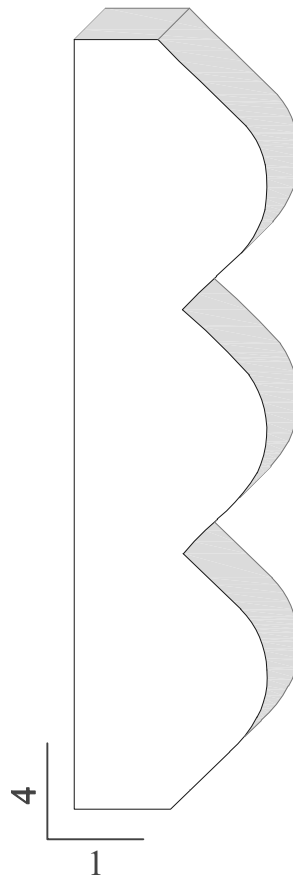

CTM | CA | 4103.1

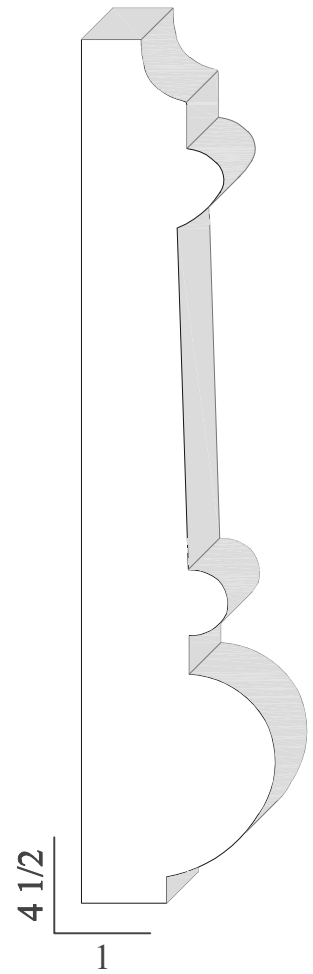

CTM | CA | 4104

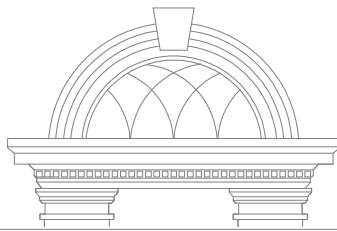

CT MOLDINGS

CASING

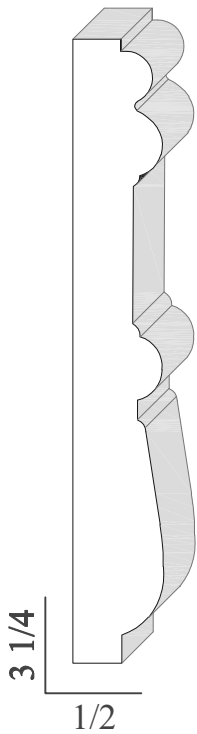

CTM | CA | 4105

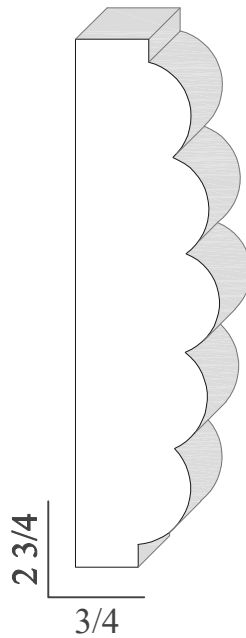

CTM | CA | 4106

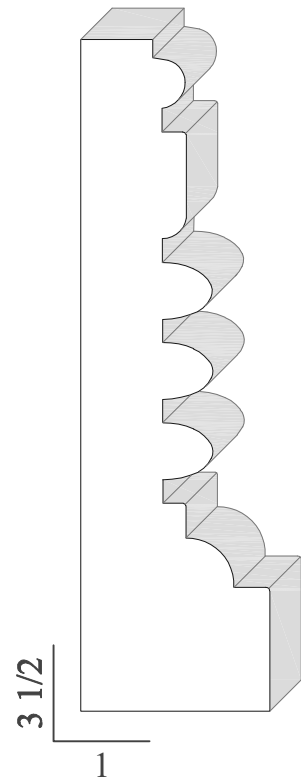

CTM | CA | 4107

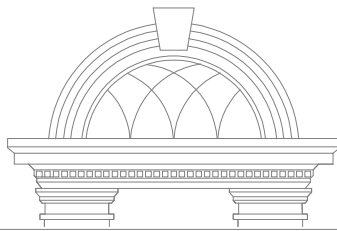

CT MOLDINGS

CASING

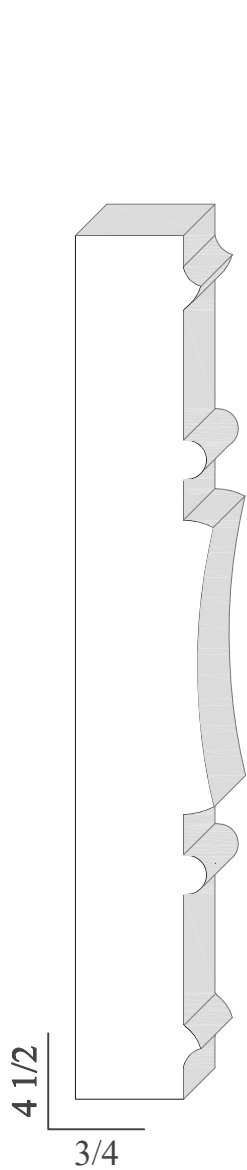

CTM | CA | 4108

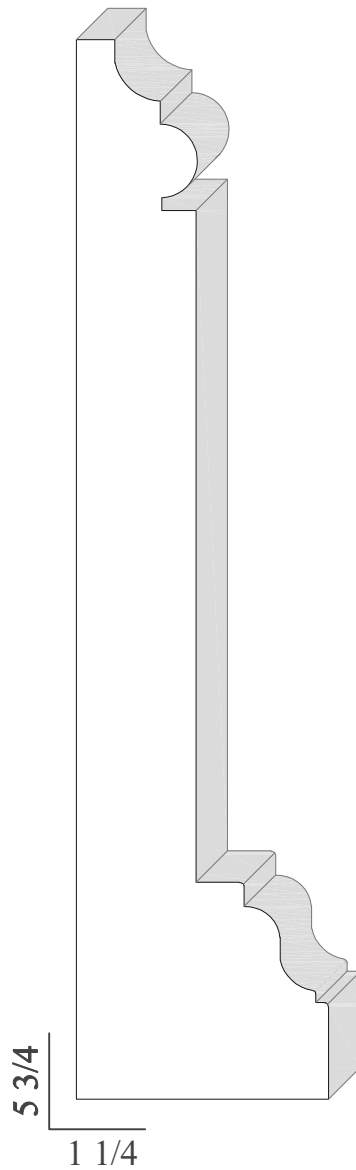

CTM | CA | 4123

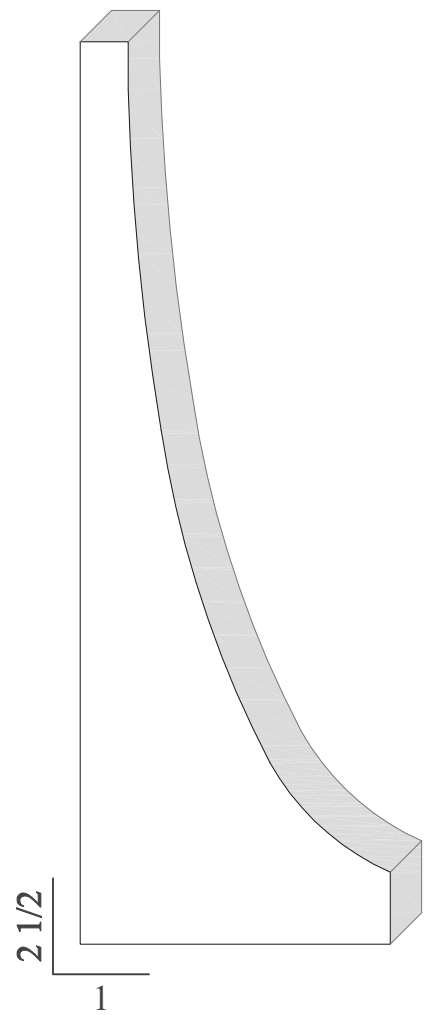

CTM | CA | 4126

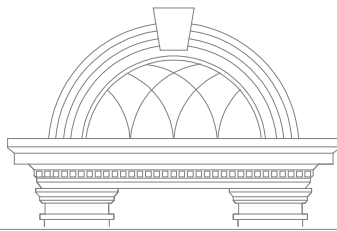

CT MOLDINGS

CASING

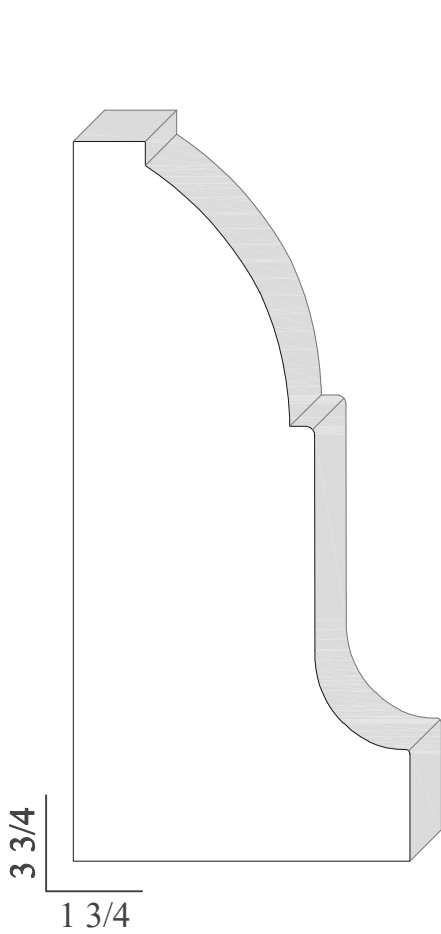

CTM | CA | 4127

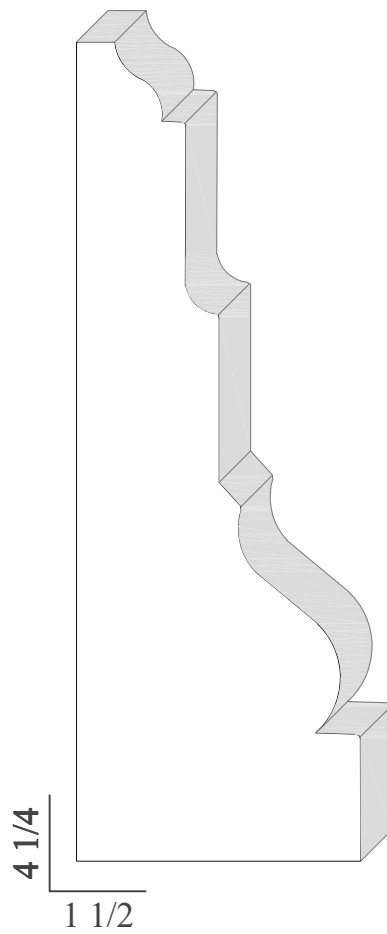

CTM | CA | 4128

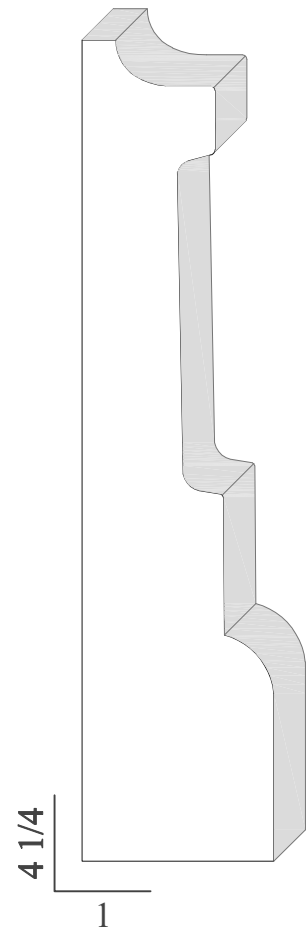

CTM | CA | 4130

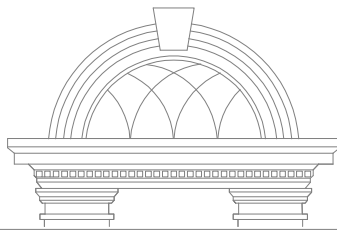

CT MOLDINGS

CASING

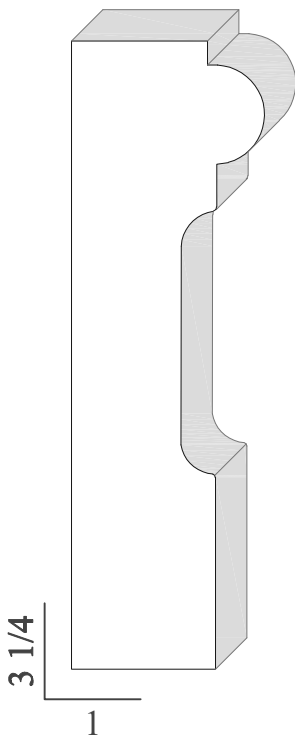

CTM | CA | 4131

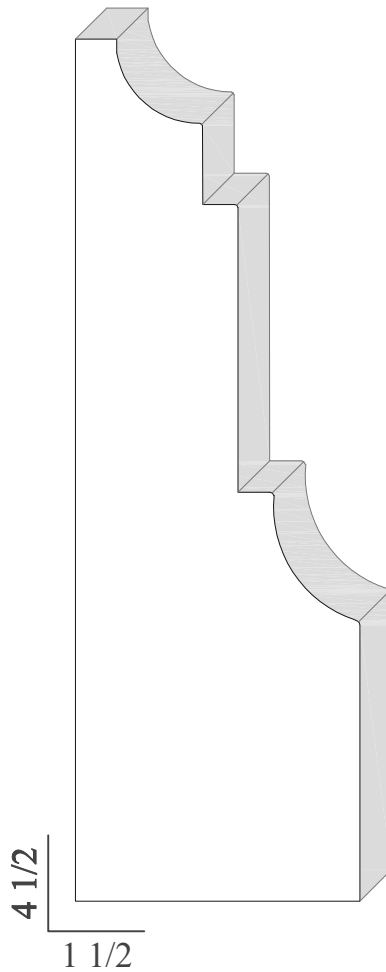

CTM | CA | 4132

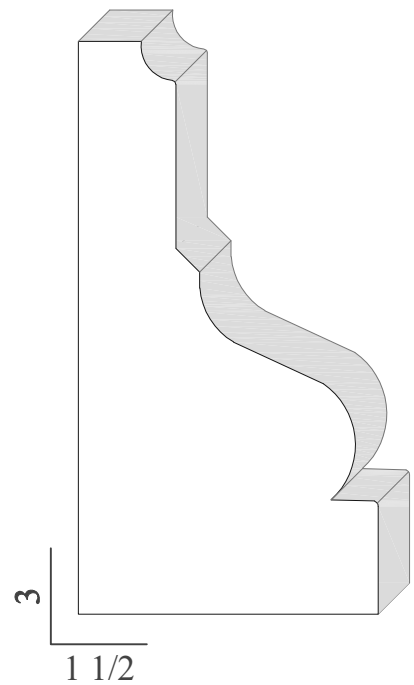

CTM | CA | 4133

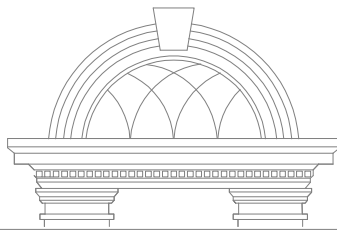

CT MOLDINGS

CASING

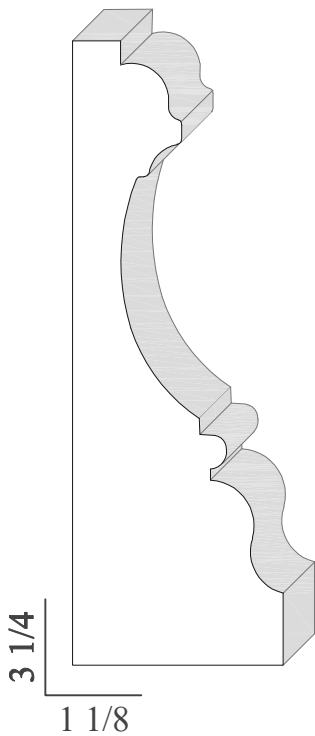

CTM | CA | 4134

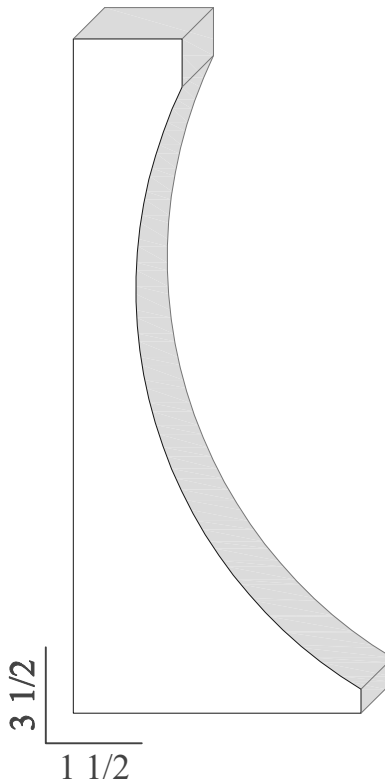

CTM | CA | 4140

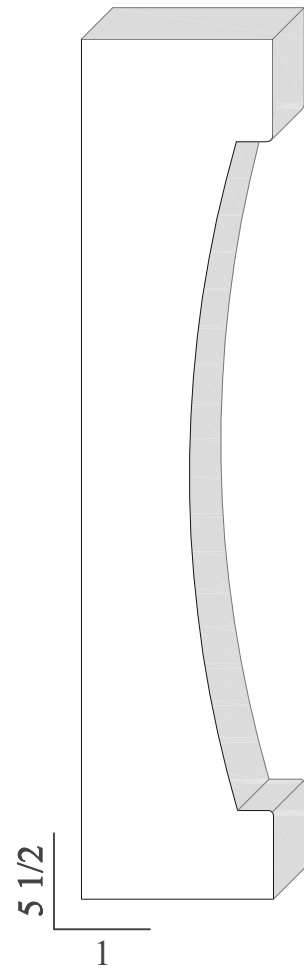

CTM | CA | 4141

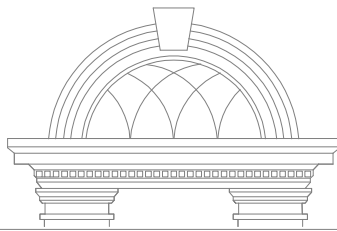

CT MOLDINGS

CASING

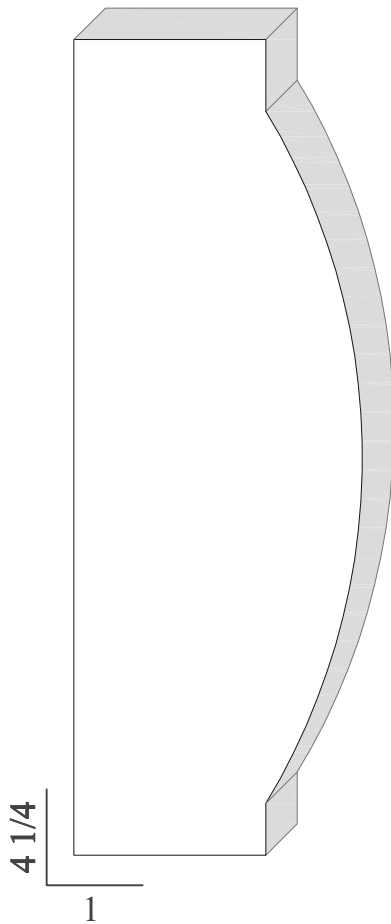

CTM | CA | 4142

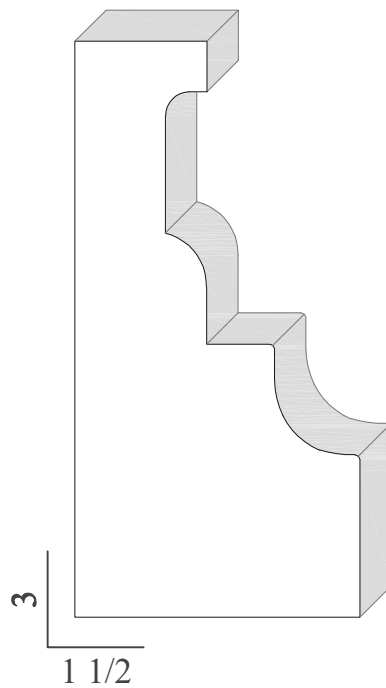

CTM | CA | 4147

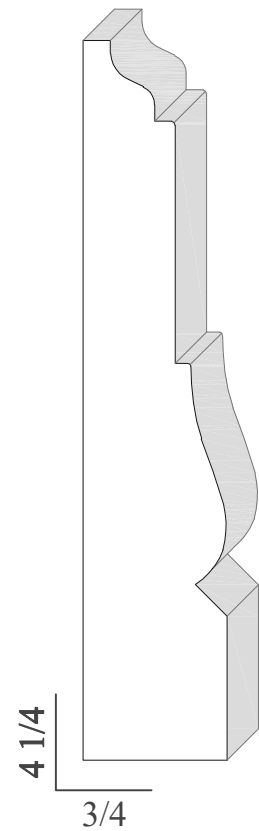

CTM | CA | 4148